



АО "Волжская металлургическая компания"

НОМЕНКЛАТУРА
профилей из алюминиевых
сплавов для
транспортного машиностроения

г. Жигулёвск

*1 Профили для транспортного
машиностроения*

1.1 Профили для автомобилей

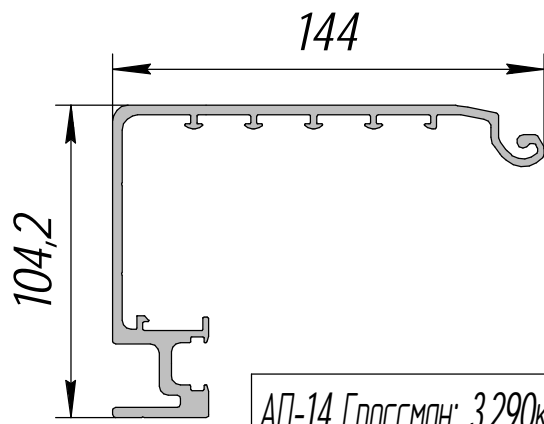

АП-14 Гроссман; 3,290кг/п.м.

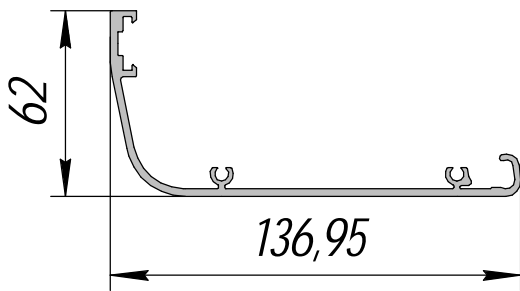

АП-15 Гроссман; 1,593кг/п.м.

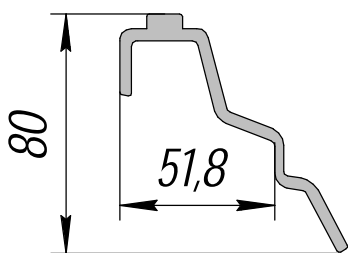

АП-23 АПС; 1,632кг/п.м.

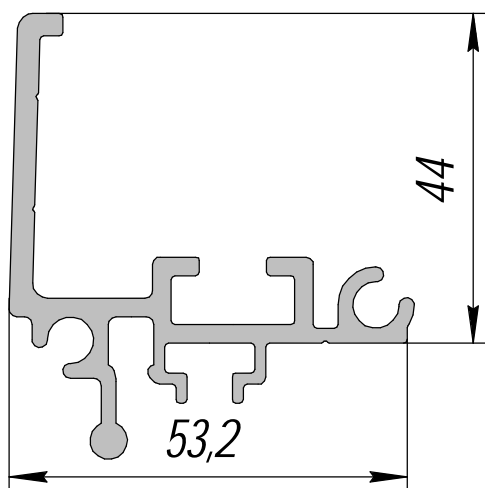

АП-25 ЛИАЗ; 1,218кг/п.м.

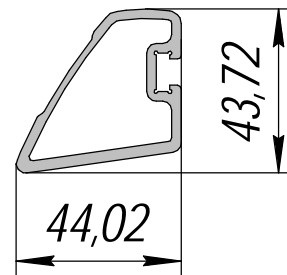

АП-39 АПС; 1,060кг/п.м.

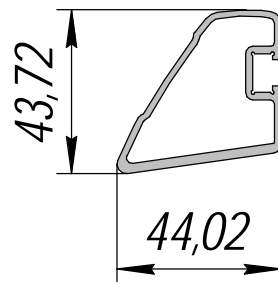

АП-39-01 АПС; 0,871кг/п.м.

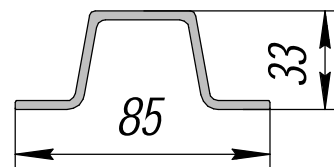

АП-41 АПС; 1,083кг/п.м.

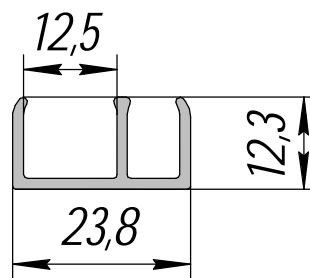

АП-44 ГАЗ; 0,224кг/п.м.

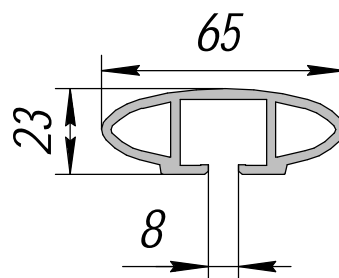

АП-45; 1,156 кг/п.м.

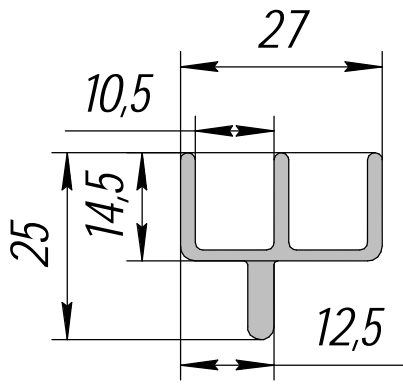

АП-46 ТС; 0,412 кг/п.м.

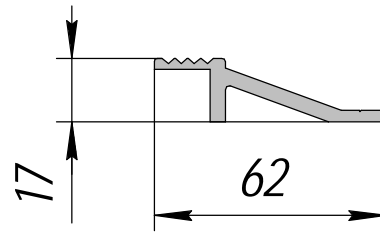

АП-50 ЛМАЗ; 0,728 кг/п.м.

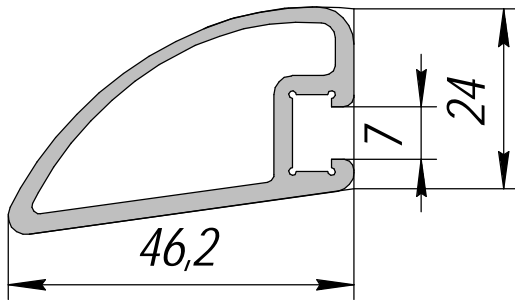

АП-47 АПС; 0,815 кг/п.м.

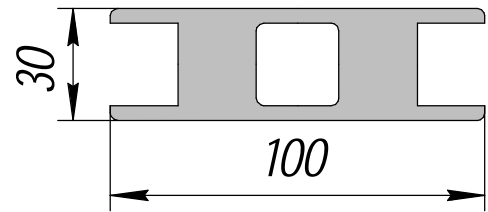

АП-51 Нефаз; 4,672 кг/п.м.

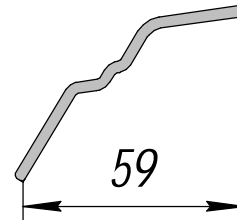

АП-56 АПС; 0,662 кг/п.м.

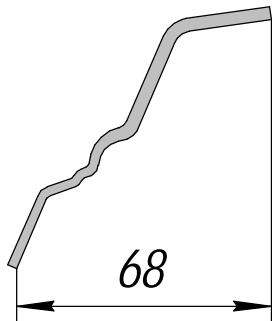

АП-48 АПС; 0,901 кг/п.м.

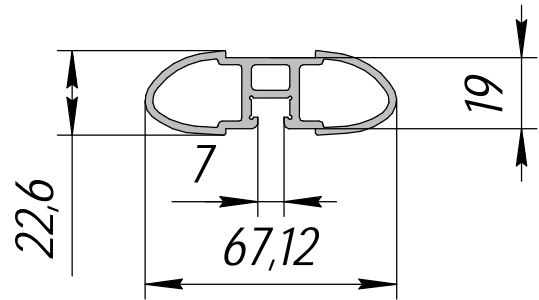

АП-57 АПС; 1,063 кг/п.м.

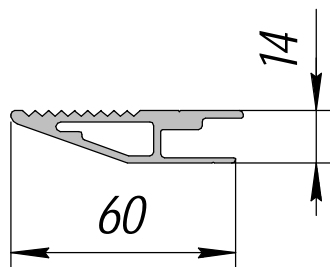

АП-49 ЛМАЗ; 0,846 кг/п.м.

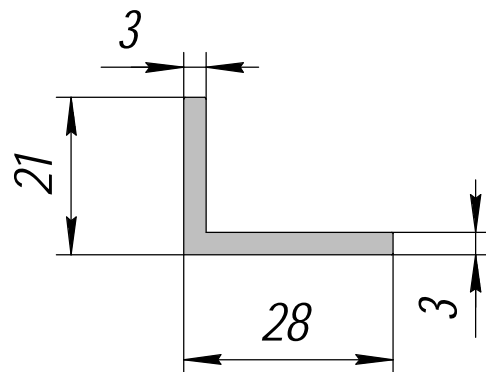

АП-58 ЮМК; 0,374 кг/п.м.

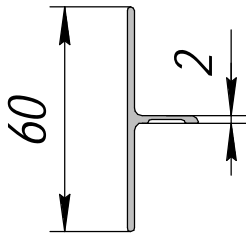

АП-60 ЮМК; 0,391 кг/п.м.

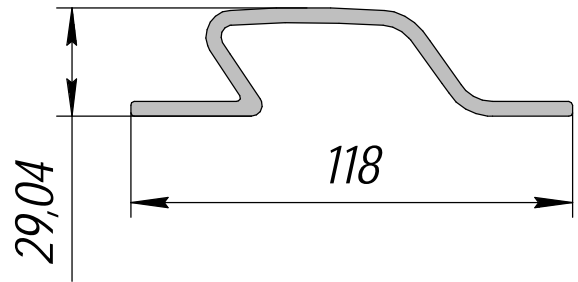

АП-63 АПС; 1,784 кг/п.м.

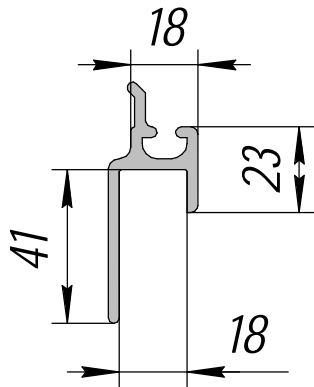

АП-61 ПАЗ; 0,925 кг/п.м.

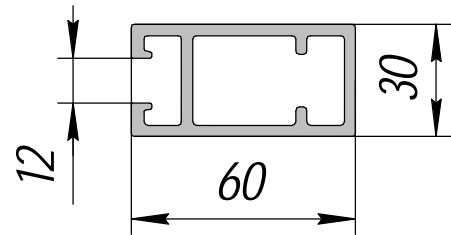

АП-64 Нефаз; 1,583 кг/п.м.

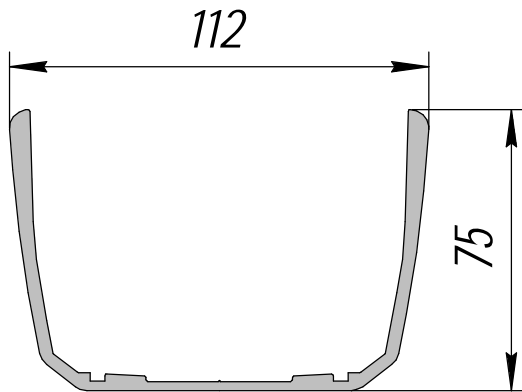

АП-62; 2,323 кг/п.м.

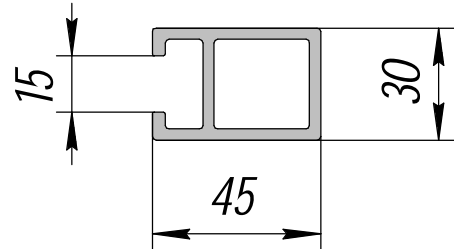

АП-65 Нефаз; 1,209 кг/п.м.

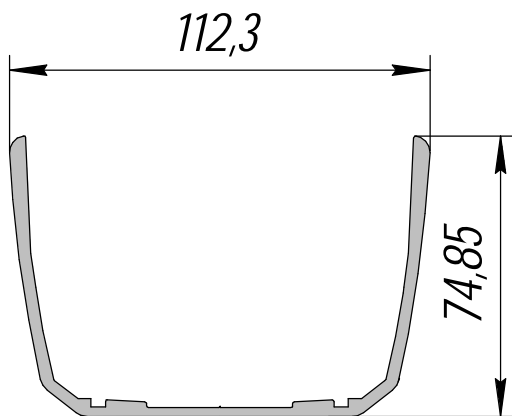

АП-62-2; 2,111 кг/п.м.

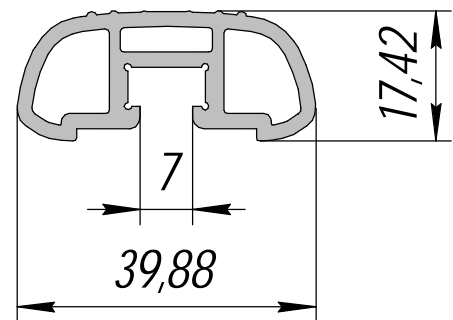

АП-66 АПС; 0,682 кг/п.м.

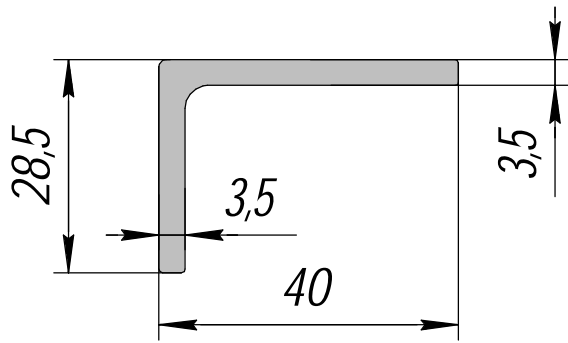

АП-67 АПС; 0,621 кг/п.м.

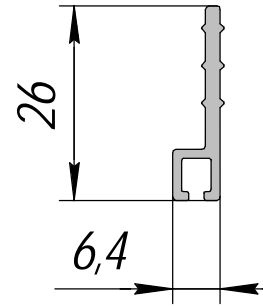

АП-71 Нефаз; 0,173 кг/п.м.

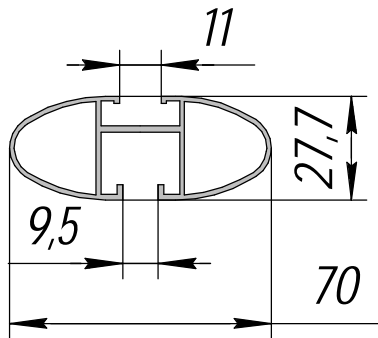

АП-68; 0,795 кг/п.м.

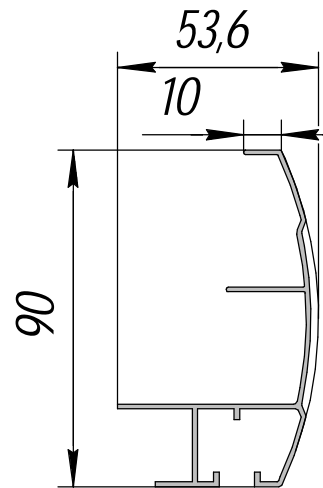

АП-72; 0,788 кг/п.м.

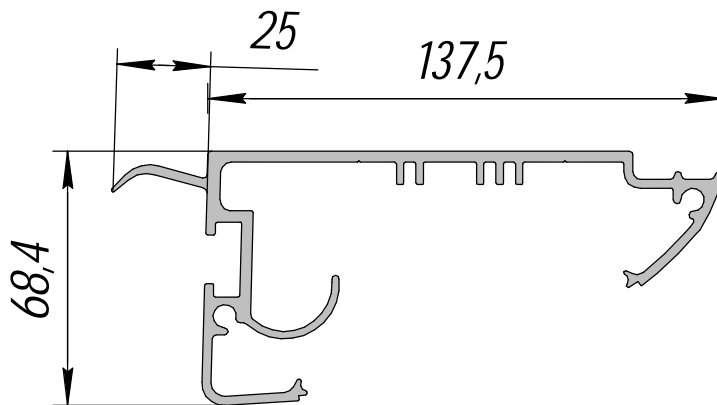

АП-69 ЛИАЗ; 2,908 кг/п.м.

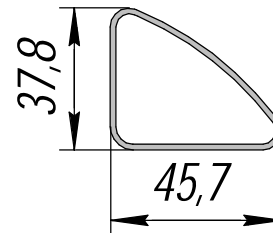

АП-73 ВМ-А; 0,551 кг/п.м.

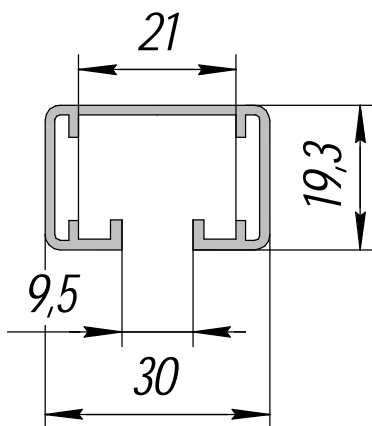

АП-70; 2,323 кг/п.м.

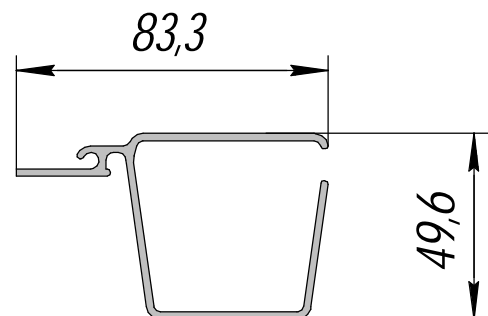

АП-74 ВМ-А; 1,176 кг/п.м.

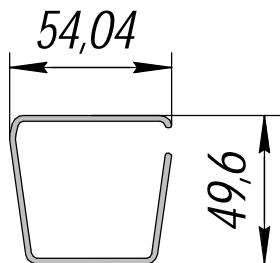

АП-74-01 ВМ-А; 0,953 кг/п.м.

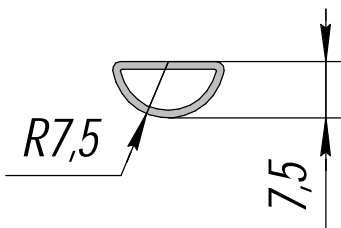

АП-75 ВМ-А; 0,093 кг/п.м.

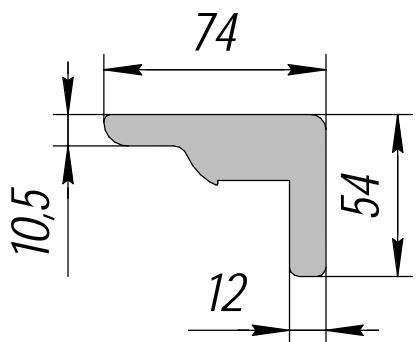

АП-76 АПС; 4,482 кг/п.м.

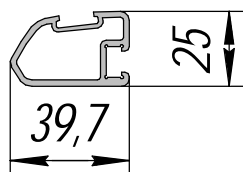

АП-77 АПС; 0,673 кг/п.м.

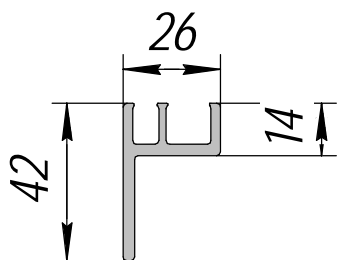

АП-78; 0,652 кг/п.м.

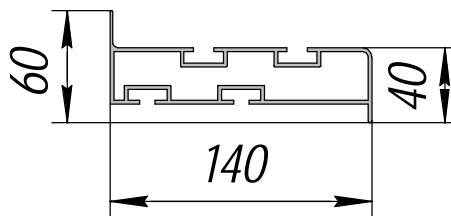

АП-81; 2,521 кг/п.м.

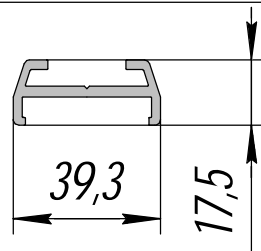

АП-82 Лицз; 0,557 кг/п.м.

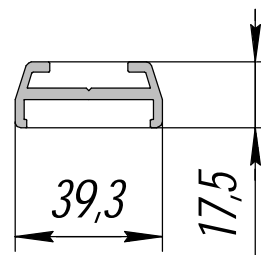

АП-83 Лицз; 0,501 кг/п.м.

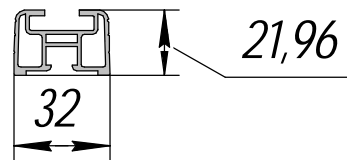

АП-86 АПС; 0,563 кг/п.м.

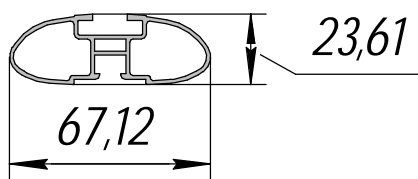

АП-87 АПС; 0,744 кг/п.м.

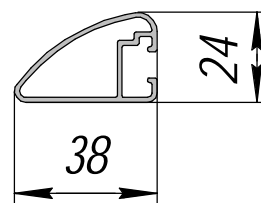

АП-88; 0,433 кг/п.м.

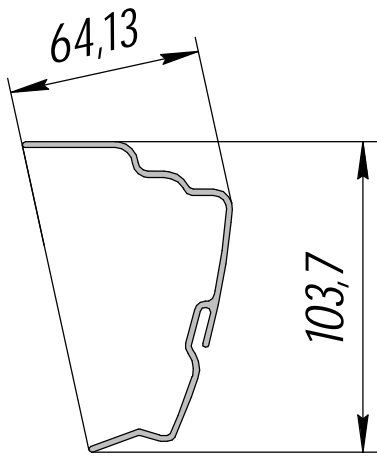

АП-89 АПС; 1,122 кг/п.м.

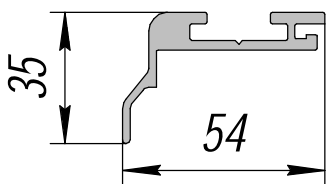

АП-90 Нефаз; 0,869 кг/п.м.

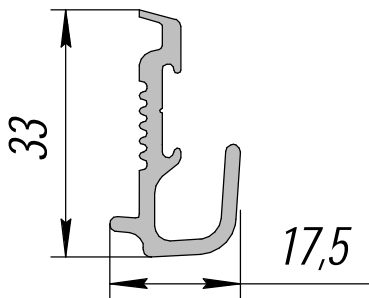

АП-91 ПАЗ; 0,382 кг/п.м.

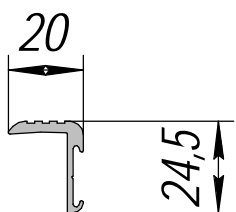

АП-92 ПАЗ; 0,281 кг/п.м.

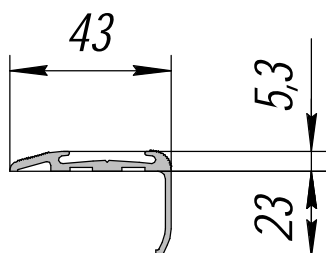

АП-93 ПАЗ; 0,405 кг/п.м.

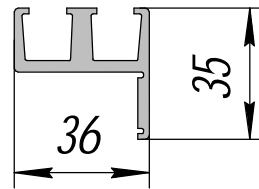

АП-94 СМК; 0,847 кг/п.м.

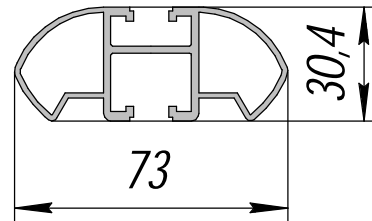

АП-95 ПКФ; 1,136 кг/п.м.

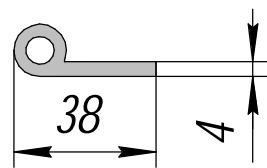

АП-96 Нефаз; 0,584 кг/п.м.

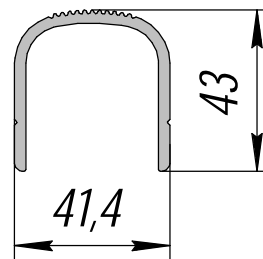

АП-97 Нефаз; 0,879 кг/п.м.

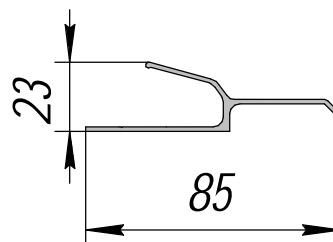

АП-99 Нефаз; 0,540 кг/п.м.

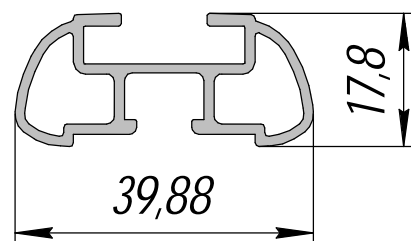

АП-100; 0,879 кг/п.м.

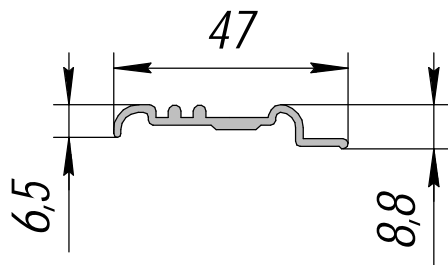

HP-324; 0,295кг/п.м.

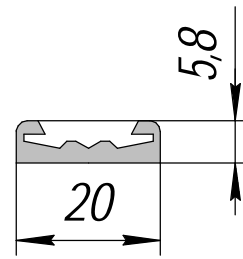

HP-363; 0,179кг/п.м.

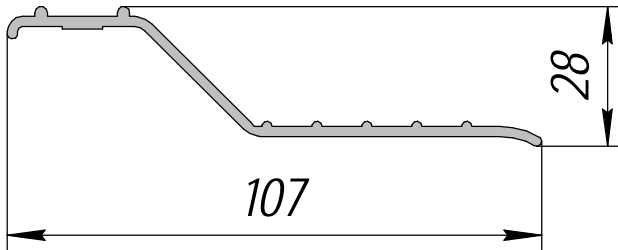

HP-325; 0,692кг/п.м.

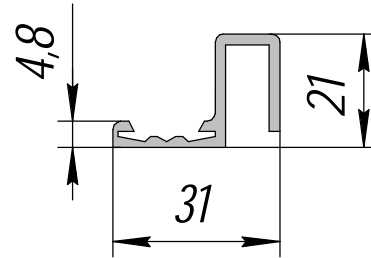

HP-364; 0,366кг/п.м.

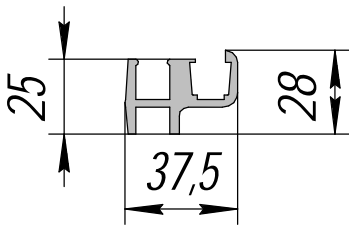

HP-360; 0,901кг/п.м.

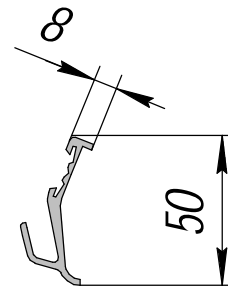

HP-365; 0,522кг/п.м.

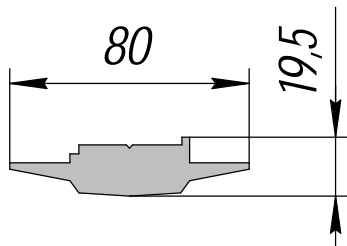

HP-361; 2,172кг/п.м.

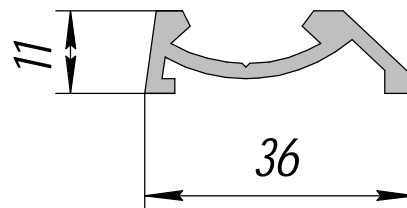

HP-366; 0,356кг/п.м.

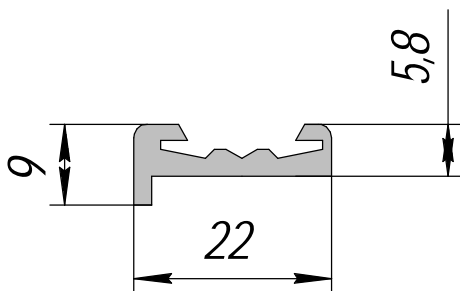

HP-362; 0,227кг/п.м.

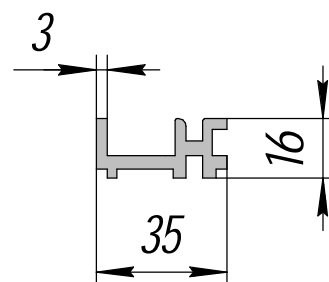

HP-367; 0,663кг/п.м.

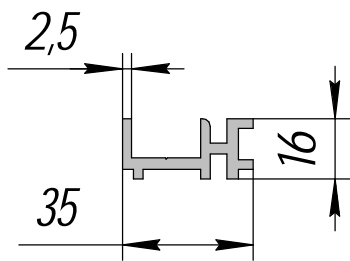

HP-367-01; 0,586кг/п.м.

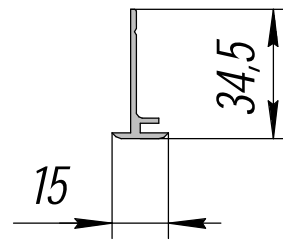

HP-374; 0,22кг/п.м.

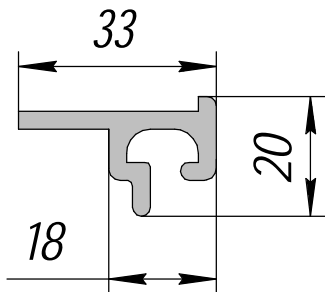

HP-368; 0,540кг/п.м.

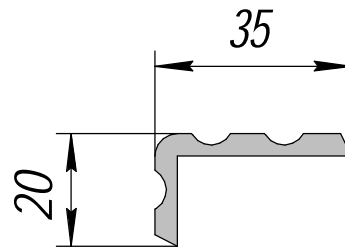

HP-375; 0,442кг/п.м.

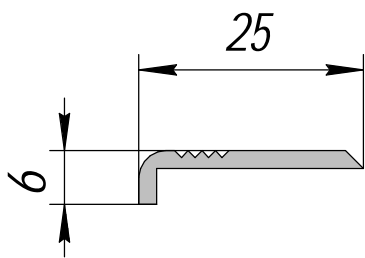

HP-369; 0,140кг/п.м.

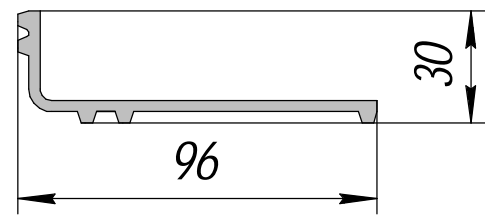

HP-376; 1,101кг/п.м.

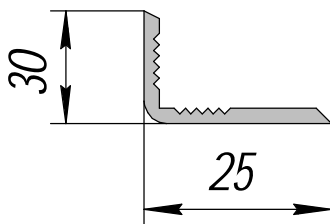

HP-372; 0,177кг/п.м.

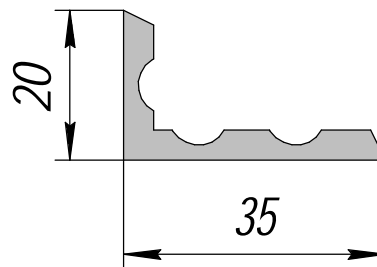

HP-377; 0,451кг/п.м.

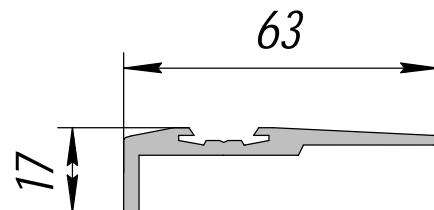

HP-378; 0,668кг/п.м.

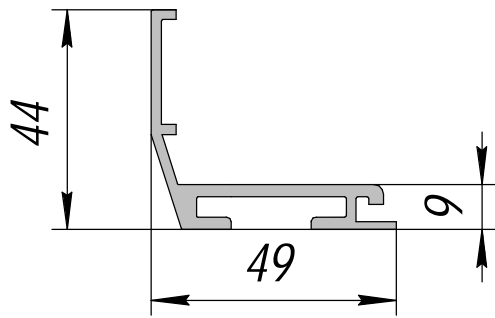

HP-380; 0,758кг/п.м.

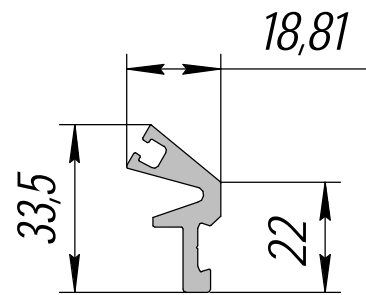

HP-384; 0,528кг/п.м.

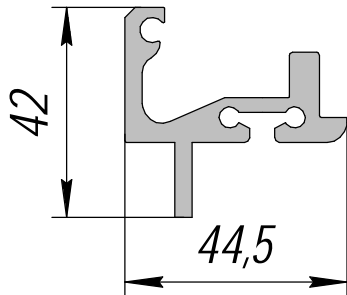

HP-381; 1,201кг/п.м.

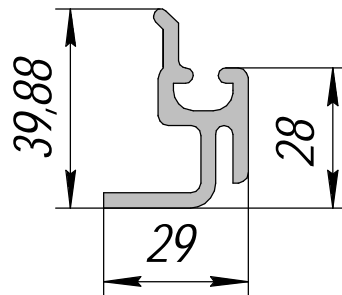

HP-385; 0,828кг/п.м.

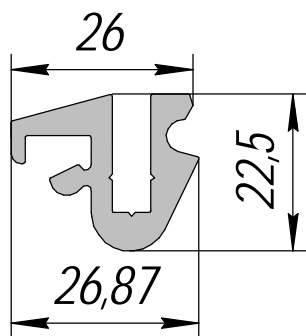

HP-382; 0,654кг/п.м.

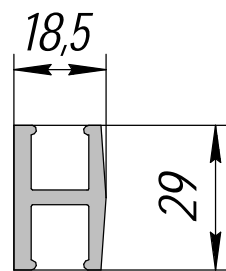

HP-386; 0,622кг/п.м.

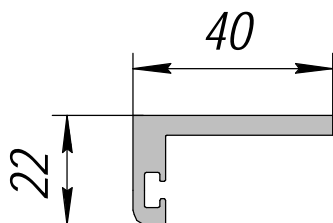

HP-383; 0,677кг/п.м.

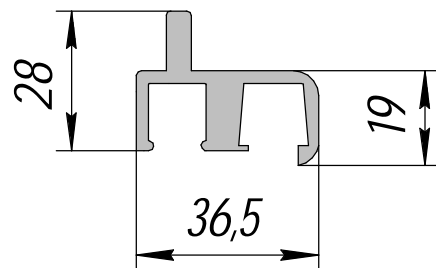

HP-387; 0,869кг/п.м.

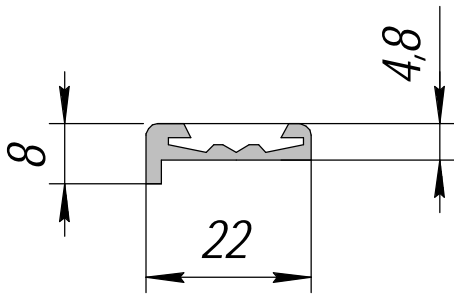

HP-388; 0,168кг/п.м.

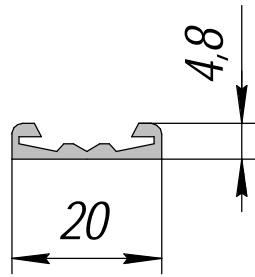

HP-389; 0,124кг/п.м.

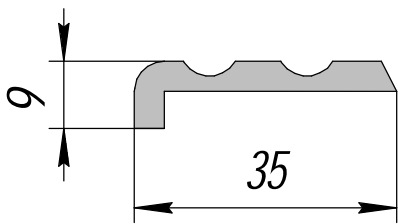

HP-390; 0,360кг/п.м.

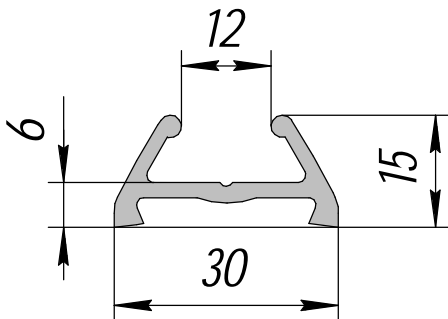

HP-396; 0,355кг/п.м.

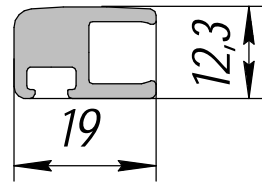

HP-397; 0,352кг/п.м.

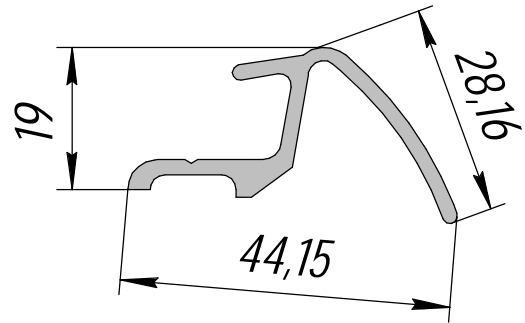

HP-399; 0,453кг/п.м.

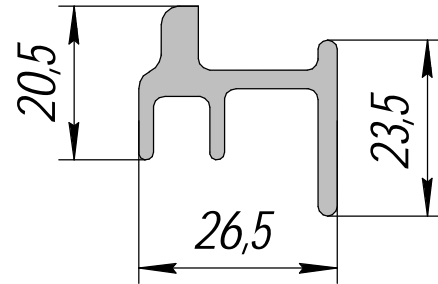

HP-400; 0,557кг/п.м.

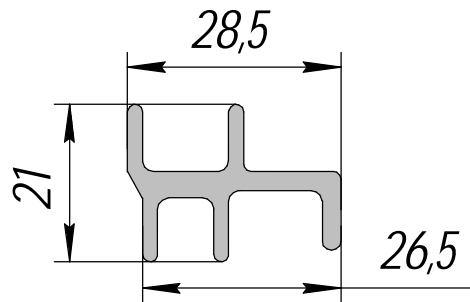

HP-401; 0,466кг/п.м.

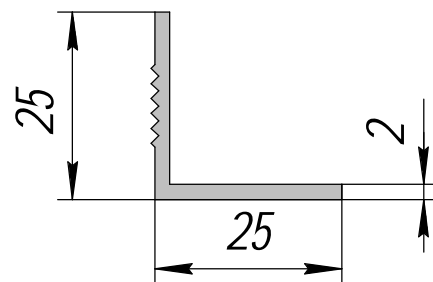

HP-402; 0,261кг/п.м.

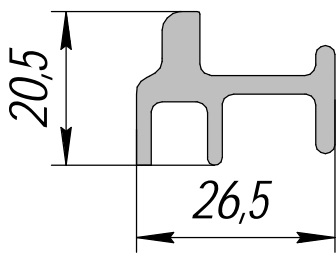

HP-404; 0,498кг/п.м.

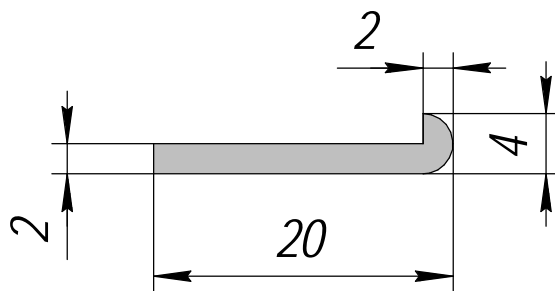

HP-424; 0,115кг/п.м.

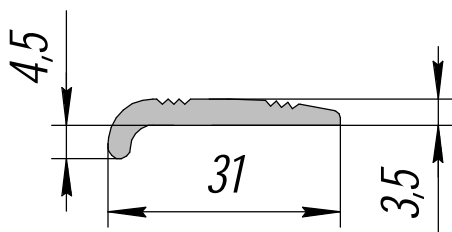

HP-405; 0,279кг/п.м.

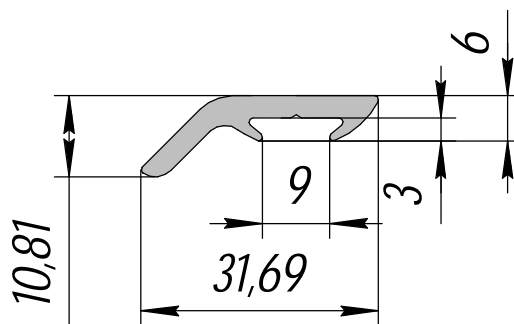

HP-425; 0,311кг/п.м.

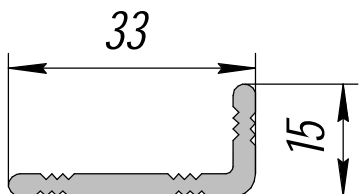

HP-406; 0,328кг/п.м.

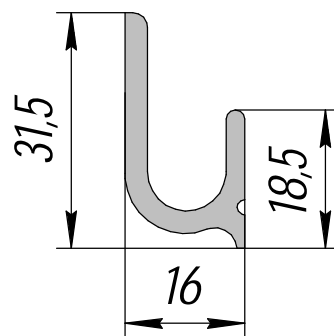

HP-426; 0,424кг/п.м.

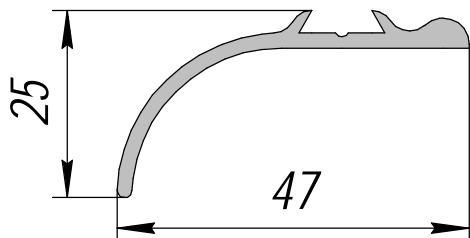

HP-408; 0,366кг/п.м.

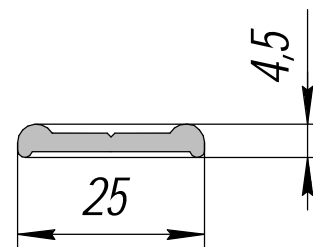

HP-427; 0,195кг/п.м.

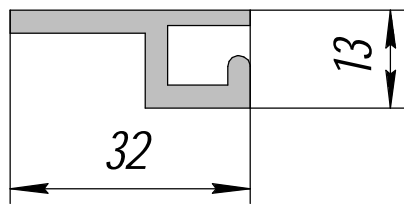

HP-429; 0,431кг/п.м.

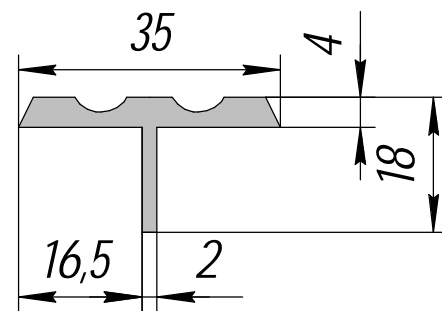

HP-433; 0,381кг/п.м.

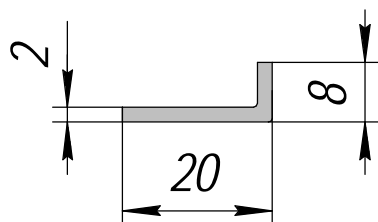

HP-430; 0,141кг/п.м.

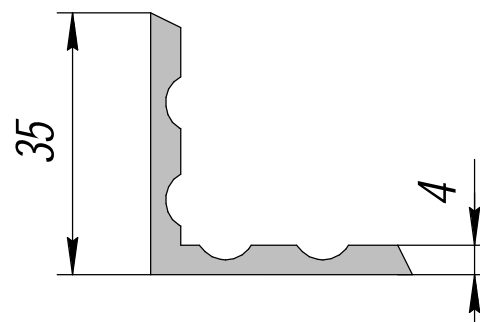

HP-434; 0,587кг/п.м.

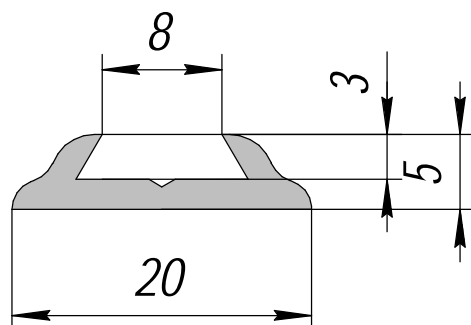

HP-431; 0,137кг/п.м.

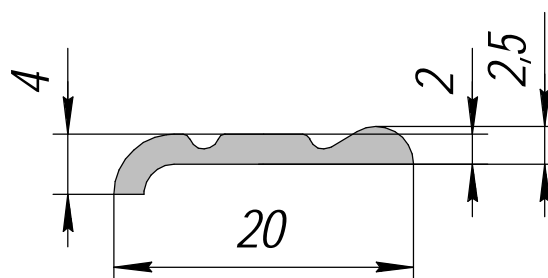

HP-435; 0,104кг/п.м.

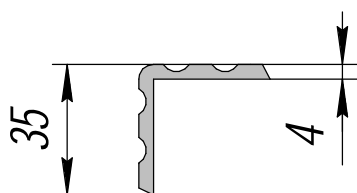

HP-432; 0,578кг/п.м.

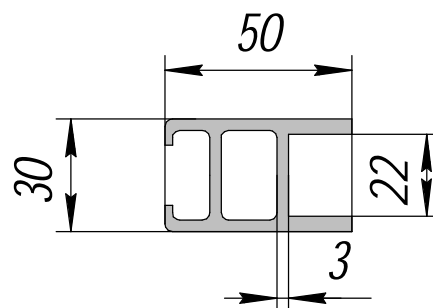

HP-436; 1,353кг/п.м.

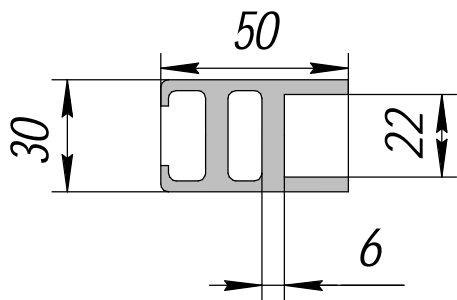

HP-436-01; 1,743кг/п.м.

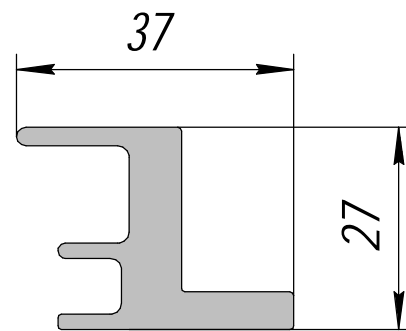

HP-507; 0,942кг/п.м.

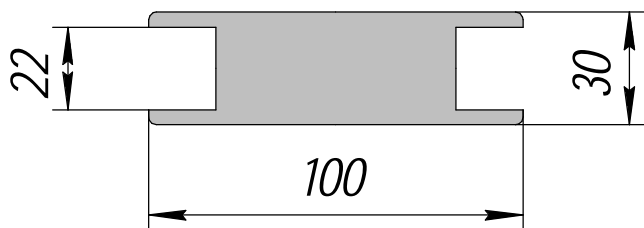

HP-437; 5,975кг/п.м.

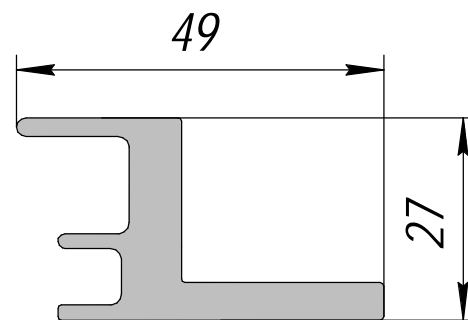

HP-508; 1,105кг/п.м.

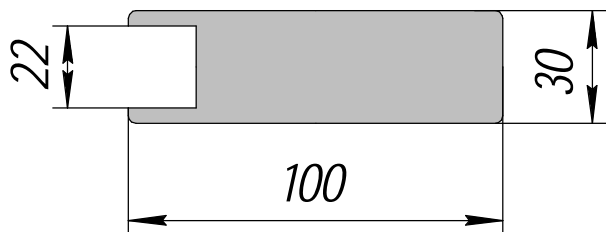

HP-438; 7,047кг/п.м.

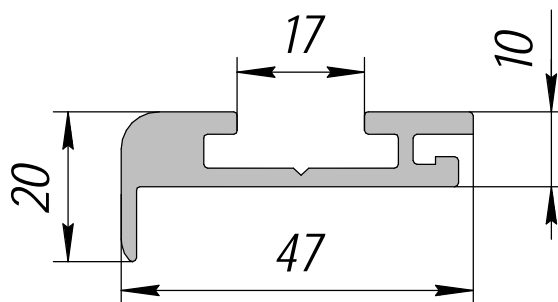

HP-509; 0,757кг/п.м.

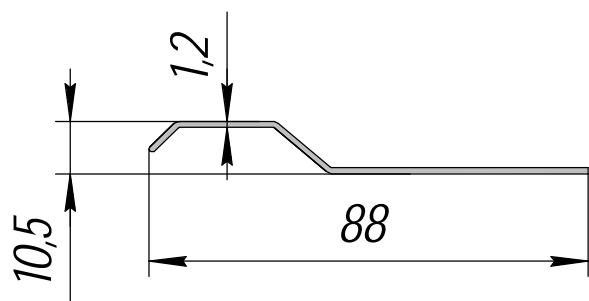

HP-505; 0,303кг/п.м.

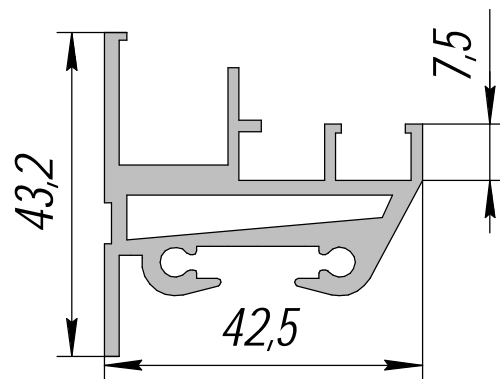

HP-511; 1,129кг/п.м.

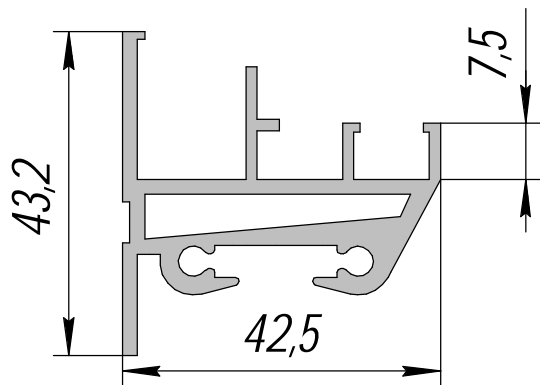

HP-512; 1,050кг/п.м.

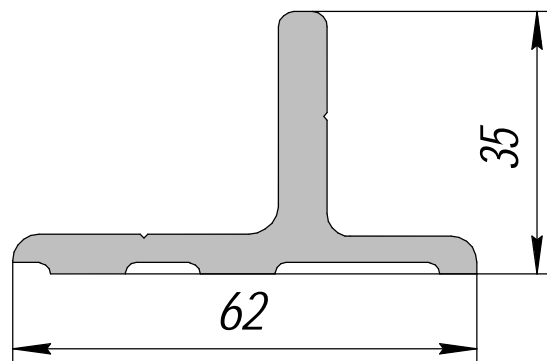

HP-516; 1,248кг/п.м.

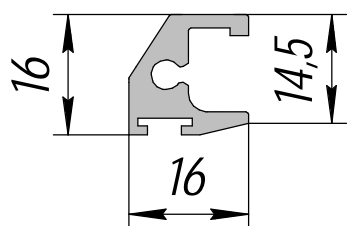

HP-513; 0,309кг/п.м.

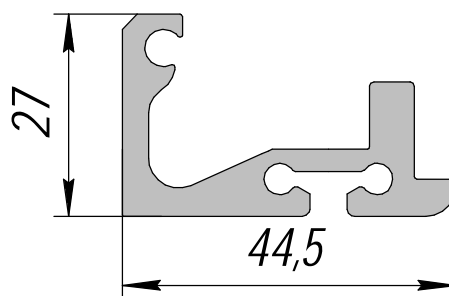

HP-517; 1,061кг/п.м.

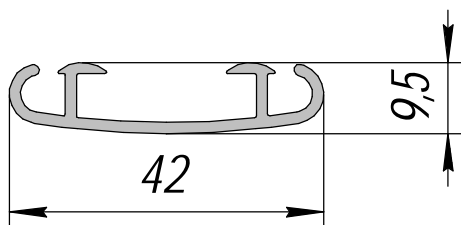

HP-514; 0,307кг/п.м.

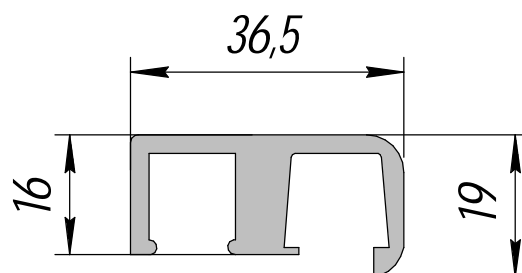

HP-518; 0,708кг/п.м.

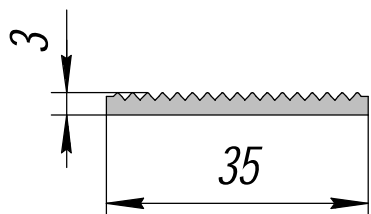

HP-515; 0,24кг/п.м.

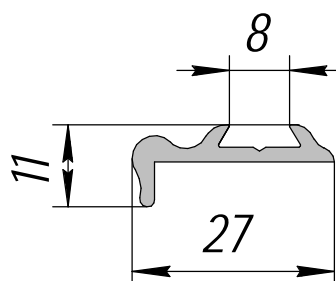

HP-519; 0,227кг/п.м.

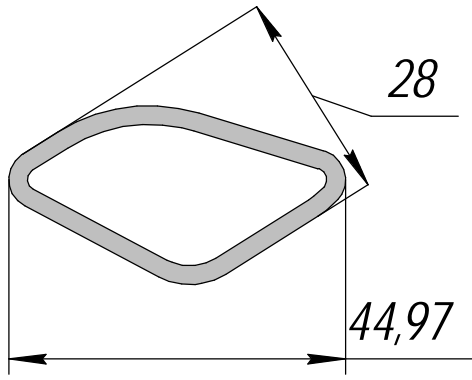

HP-540; 0,669кг/п.м.

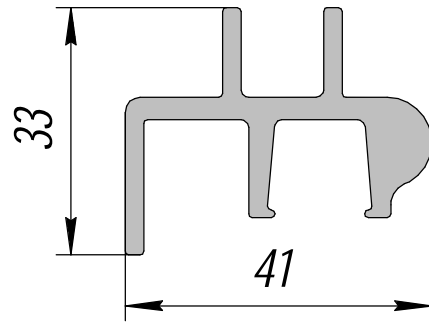

HP-590; 0,926кг/п.м.

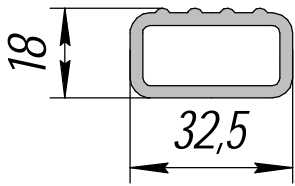

HP-570; 0,595кг/п.м.

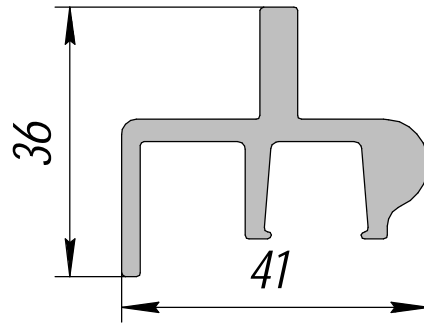

HP-591; 0,966кг/п.м.

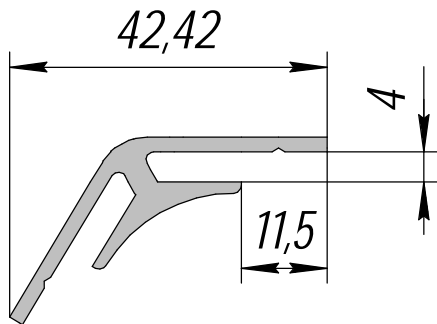

HP-587; 0,491кг/п.м.

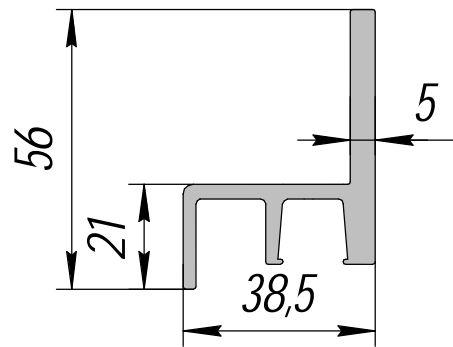

HP-593; 1,227кг/п.м.

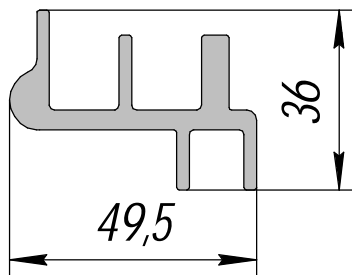

HP-588; 1,24кг/п.м.

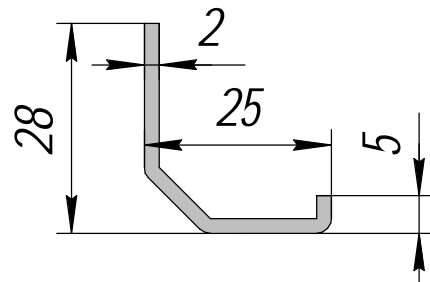

HP-595; 0,266кг/п.м.

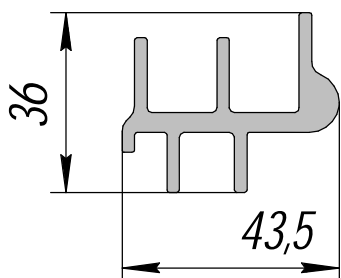

HP-589; 1,073кг/п.м.

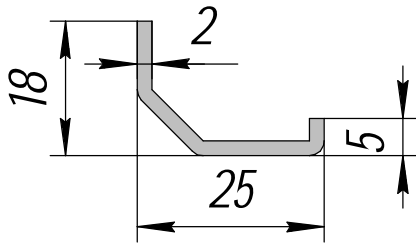

HP-595-01; 0,212кг/п.м.

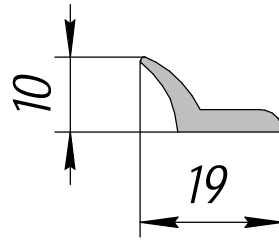

HP-599; 0,163кг/п.м.

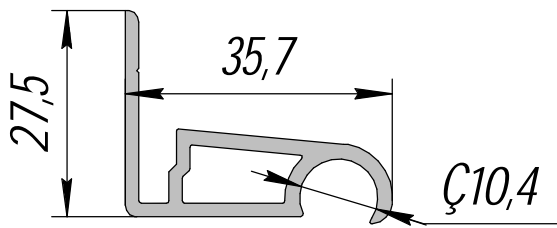

HP-596; 0,508кг/п.м.

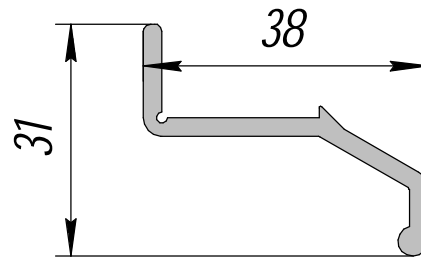

HP-600; 0,420кг/п.м.

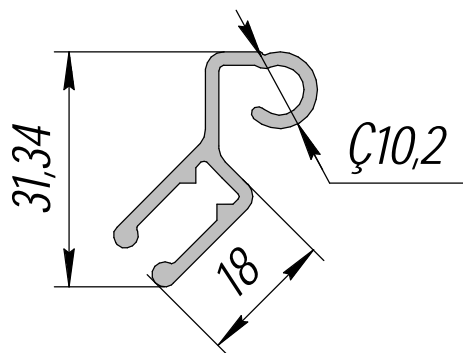

HP-597; 0,421кг/п.м.

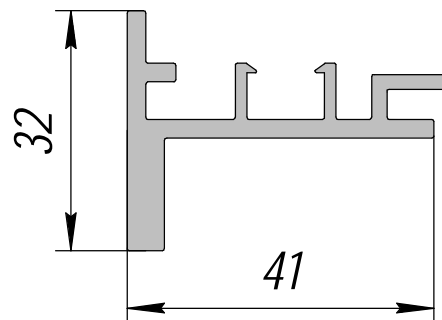

HP-601; 0,749кг/п.м.

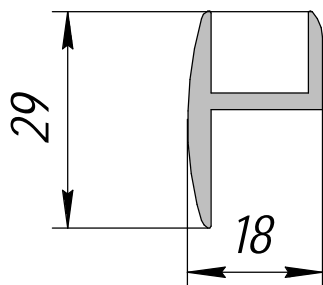

HP-598; 0,329кг/п.м.

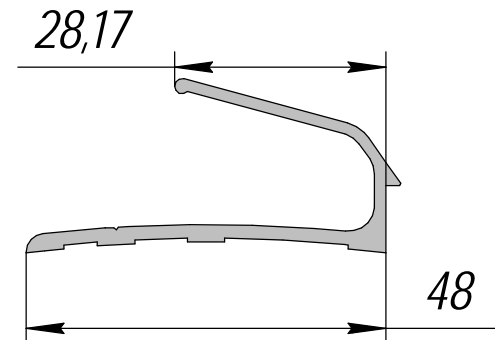

HP-602; 0,440кг/п.м.

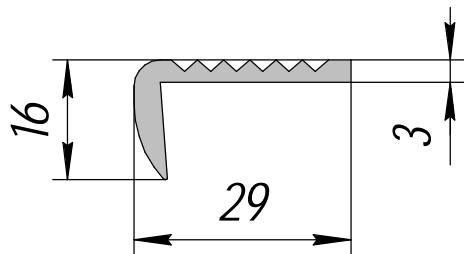

НП-603; 0,292кг/п.м.

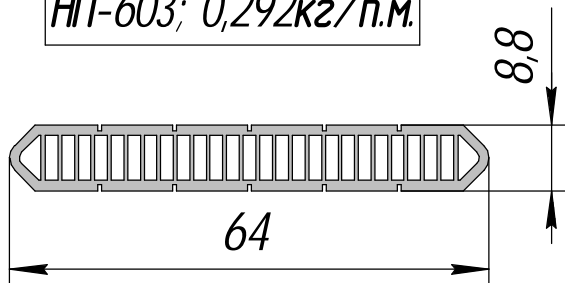

НП-608; 0,703кг/п.м.

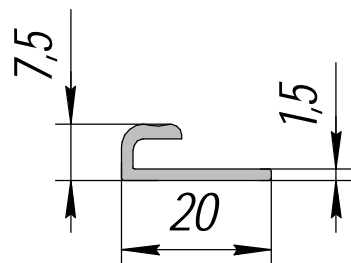

НП-631; 0,134кг/п.м.

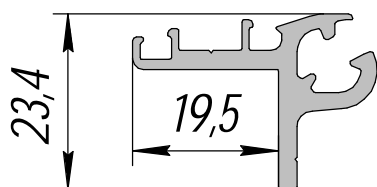

НП-639; 0,44кг/п.м.

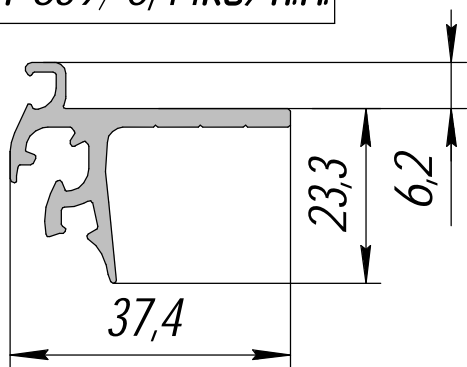

НП-640; 0,52кг/п.м.

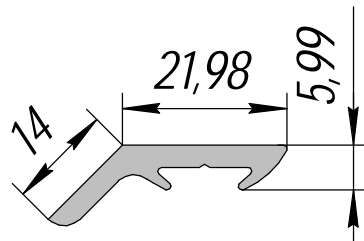

ПА-090; 0,312кг/п.м.

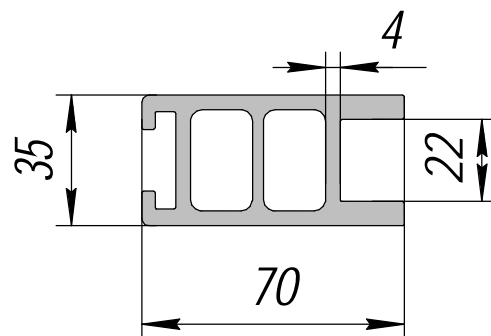

ПА-11; 2,704кг/п.м.

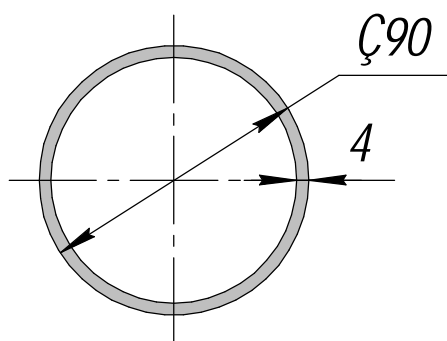

ПА-12; 2,929кг/п.м.

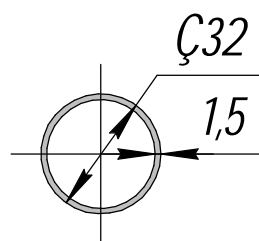

ПА-13; 0,389кг/п.м.

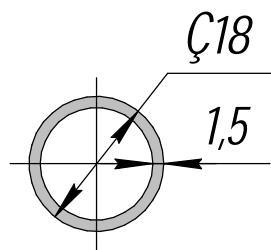

ПА-14; 0,211кг/п.м.

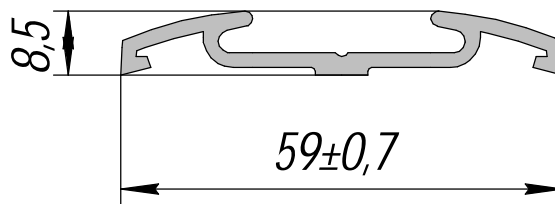

ПА-49; 0,477кг/п.м.

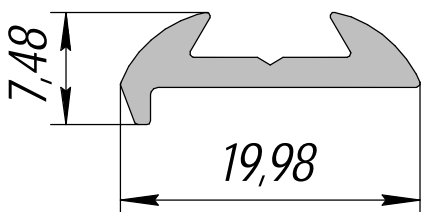

ПА-45; 0,155кг/п.м.

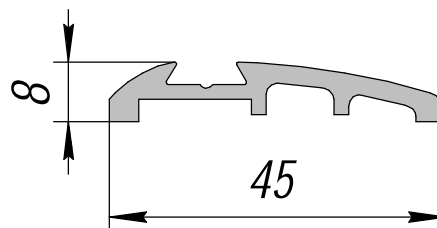

ПА-50; 0,405кг/п.м.

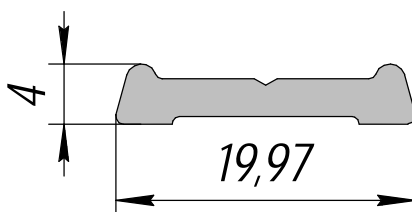

ПА-46; 0,149кг/п.м.

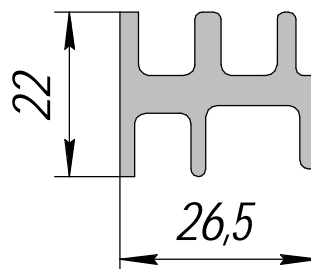

ПА-51; 0,669кг/п.м.

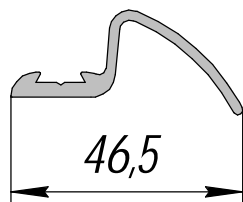

ПА-47; 0,441кг/п.м.

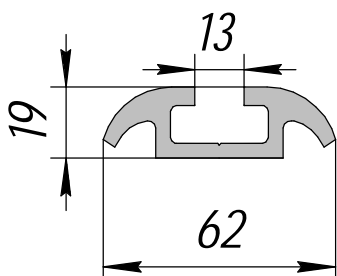

ПА-48; 1,407кг/п.м.

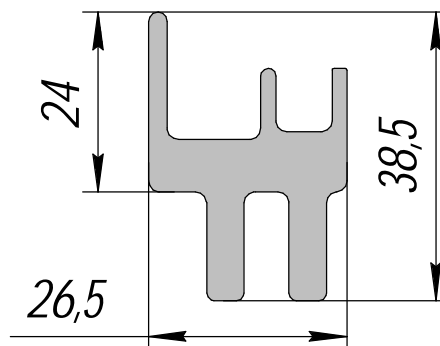

ПА-52; 1,137кг/п.м.

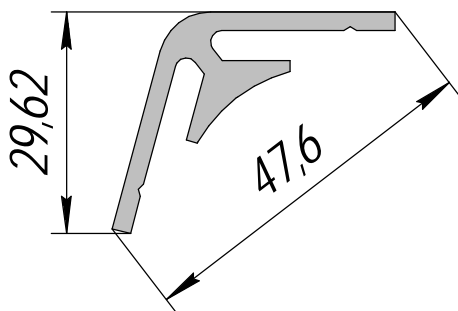

ПА-53; 0,595кг/п.м.

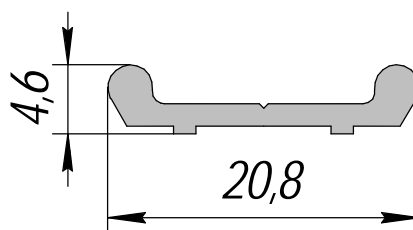

ПА-61; 0,118кг/п.м.

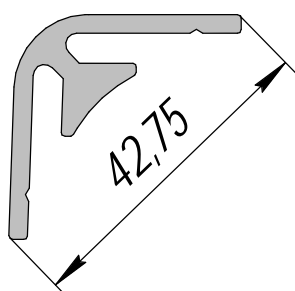

ПА-54; 0,539кг/п.м.

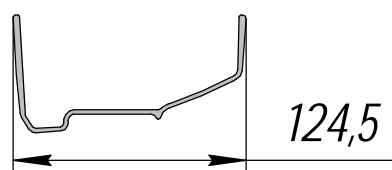

ПА-62; 1,575кг/п.м.

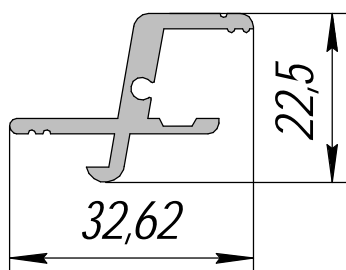

ПА-57; 0,376кг/п.м.

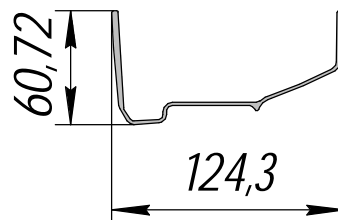

ПА-62-01; 1,361кг/п.м.

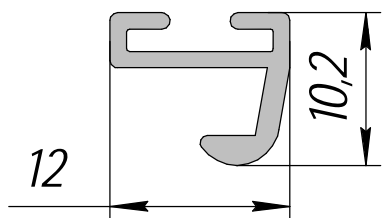

ПА-58; 0,106кг/п.м.

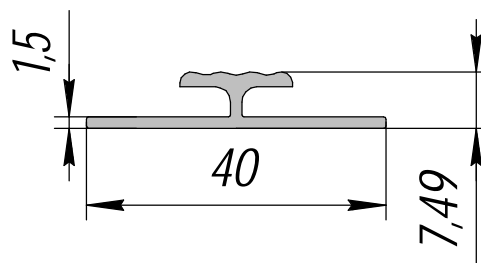

ПА-63; 0,256кг/п.м.

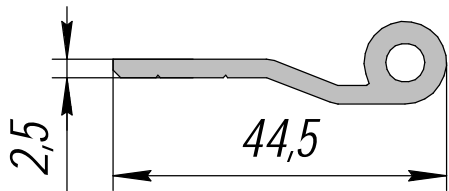

ПА-64; 0,445кг/п.м.

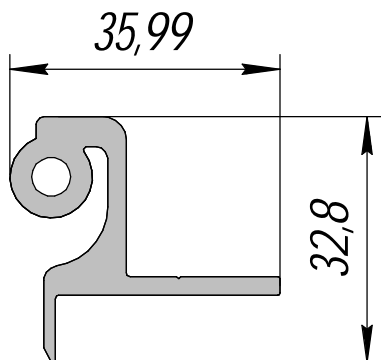

ПА-65; 0,738кг/п.м.

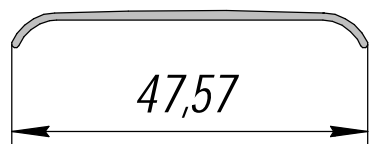

ПА-66; 0,157кг/п.м.

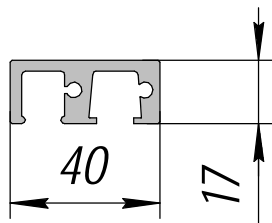

ПА-68; 0,859кг/п.м.

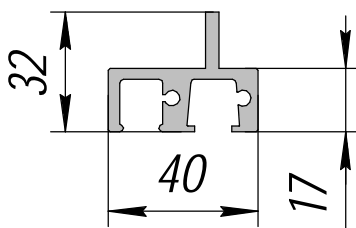

ПА-69; 1,002кг/п.м.

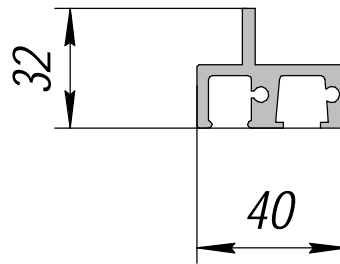

ПА-70; 1,002кг/п.м.

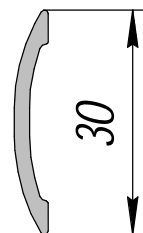

ПА-76; 0,164кг/п.м.

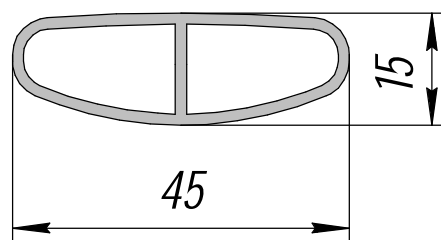

ПА-98; 0,453кг/п.м.

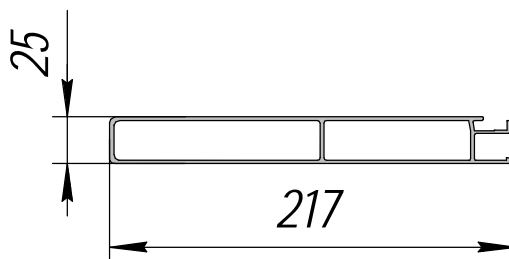

ПА-103; 2,538кг/п.м.

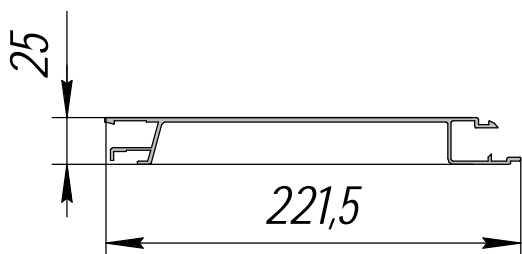

ПА-104; 1,975кг/п.м.

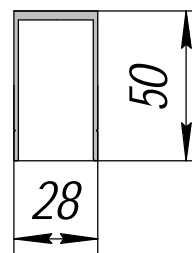

ПА-110; 0,608кг/п.м.

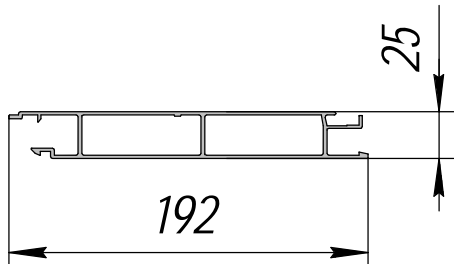

ПА-105; 2,270кг/п.м.

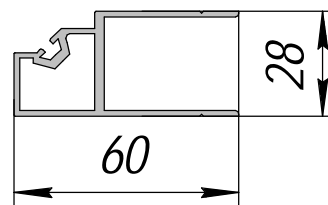

ПА-111; 0,794кг/п.м.

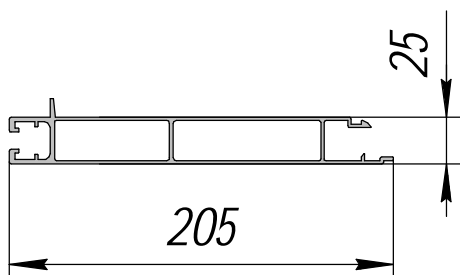

ПА-106; 2,662кг/п.м.

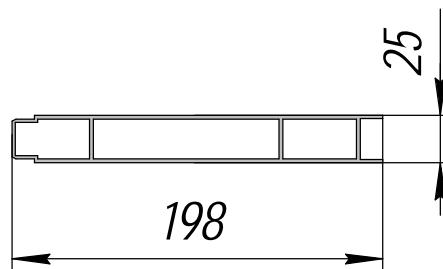

ПА-112; 2,358кг/п.м.

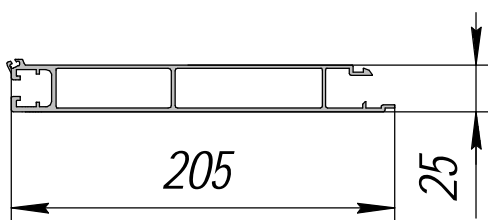

ПА-106-01; 2,652кг/п.м.

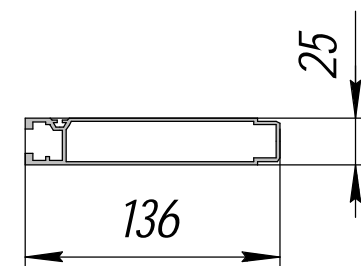

ПА-113; 1,703кг/п.м.

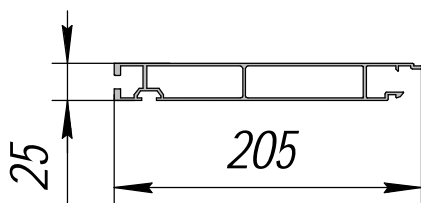

ПА-106-02; 2,543 кг/п.м.

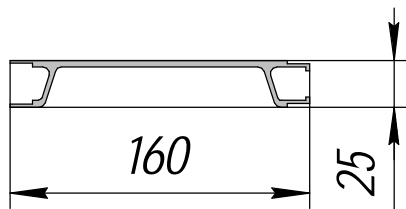

ПА-114; 1,932кг/п.м.

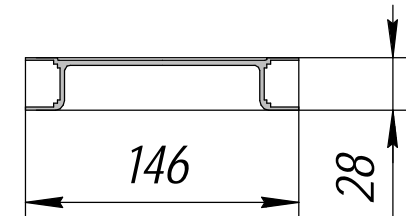

ПА-115; 1,444кг/п.м.

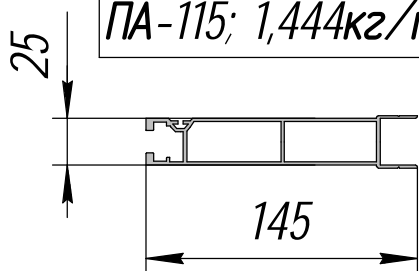

ПА-116; 1,858кг/п.м.

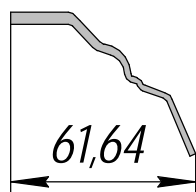

ПА-117; 0,626кг/п.м.

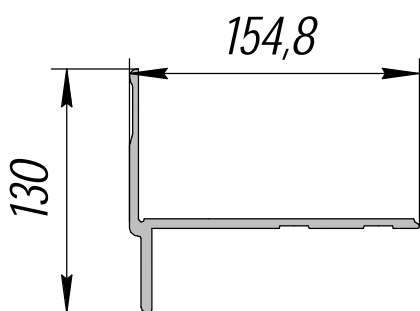

ПА-196; 3,636кг/п.м.

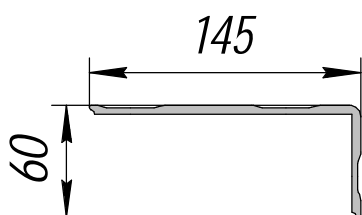

ПА-197; 2,227кг/п.м.

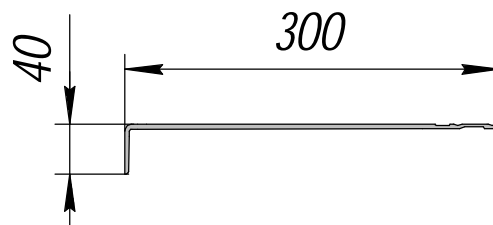

ПА-199; 3,179кг/п.м.

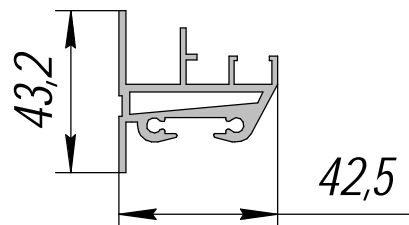

ПА-202; 1,047кг/п.м.

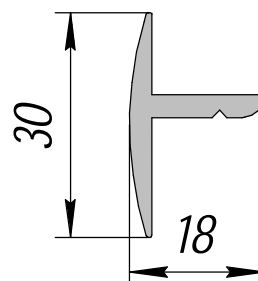

ПА-203; 0,296кг/п.м.

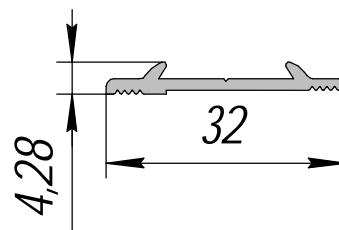

ПА-323; 0,156кг/п.м.

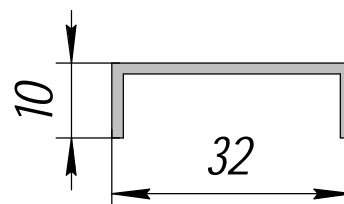

ПА-324; 0,199кг/п.м.

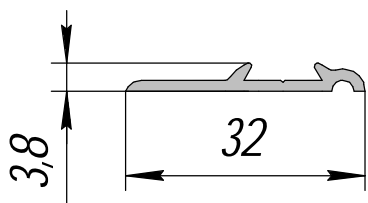

ПА-325; 0,151кг/п.м.

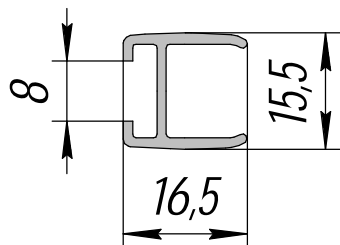

ПО-125-1; 0,178кг/п.м.

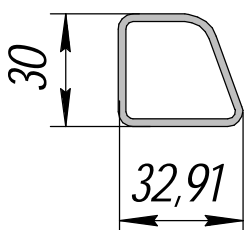

ПП-14; 0,574кг/п.м.

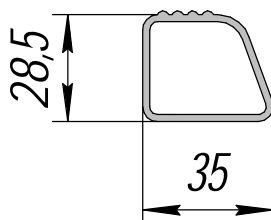

ПП-179; 0,575кг/п.м.

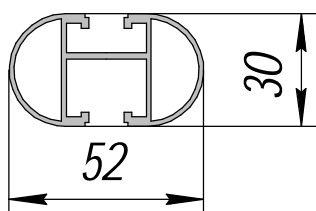

ПП-277; 0,773кг/п.м.

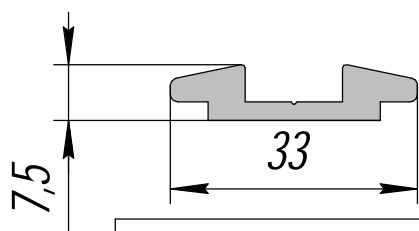

ПП-489; 0,373кг/п.м.

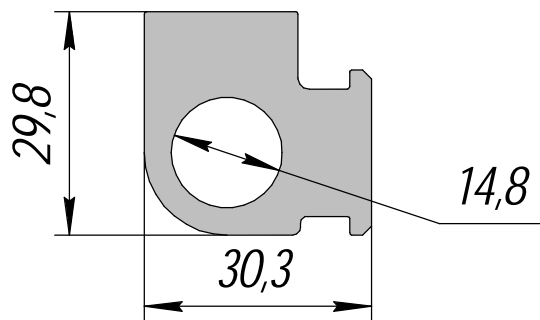

ПП-593; 1,609кг/п.м.

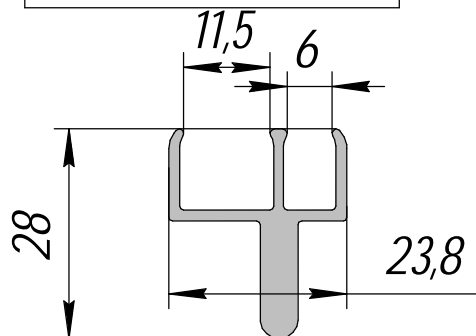

ПС 885-1299; 0,430кг/п.м.

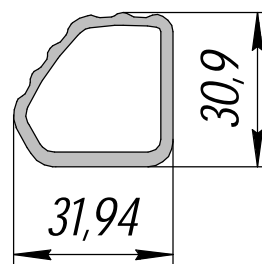

ЭПЗ-029; 0,664кг/п.м.

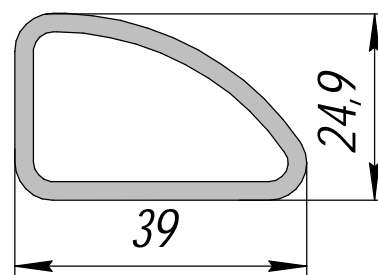

ЭПЗ-029-01; 0,687кг/п.м.

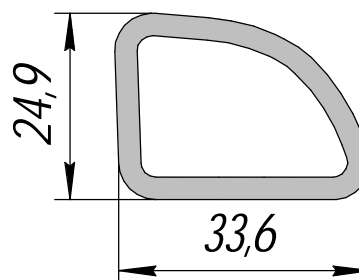

ЭПЗ-029-02; 0,751кг/п.м.

1.2 Профили для вагоностроения

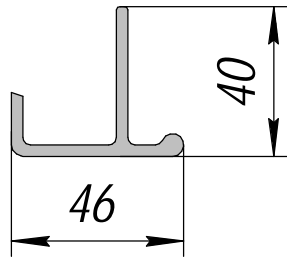

АБТ-74; 0,819кг/п.м.

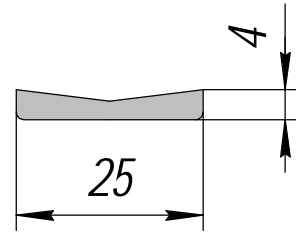

АПР 224; 0,219кг/п.м.

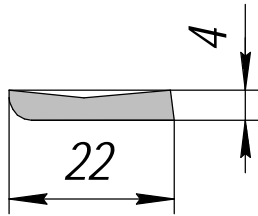

АПР 104А; 0,201кг/п.м.

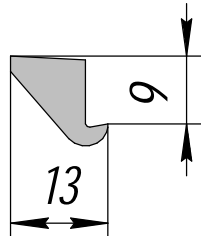

АПР 120; 0,217кг/п.м.

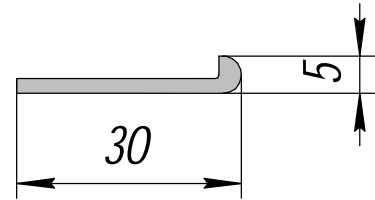

АПР 254; 0,180кг/п.м.

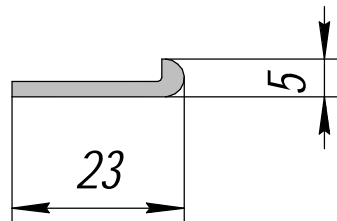

АПР 143; 0,142кг/п.м.

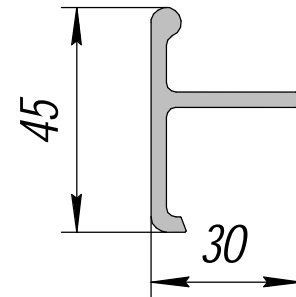

АПР-277; 0,649кг/п.м.

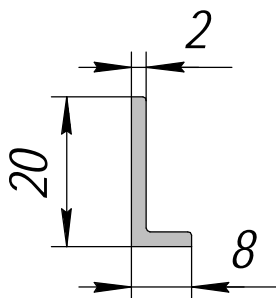

АПР 144; 0,141кг/п.м.

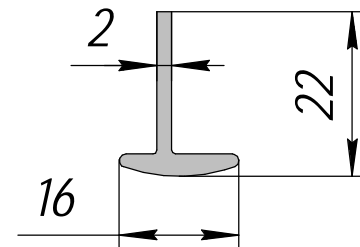

АПР 290; 0,211кг/п.м.

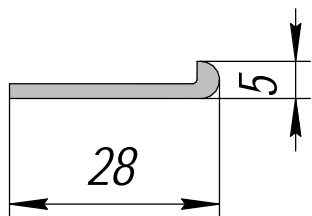

АПР 291-1; 0,169кг/п.м.

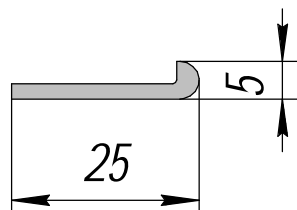

АПР 291-2; 0,153кг/п.м.

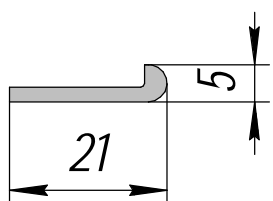

АПР 323; 0,131кг/п.м.

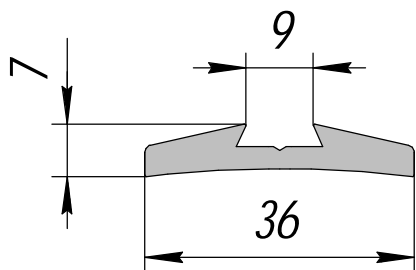

ПВ-1182; 0,424кг/п.м.

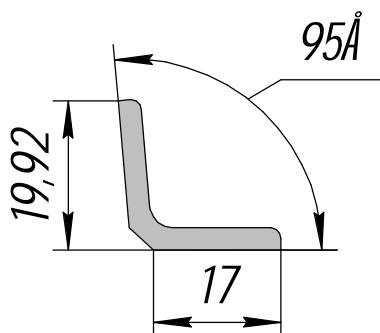

ПВ 1717; 0,292кг/п.м.

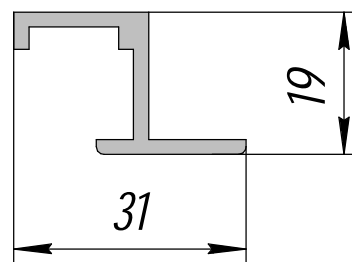

ПК 02082; 0,319кг/п.м.

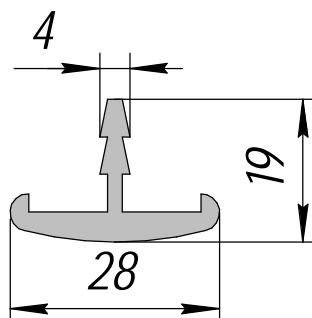

ПК 02090-1; 0,383кг/п.м.

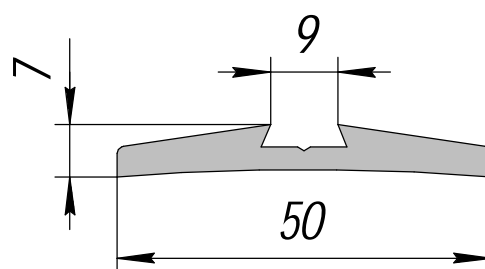

ПК 02090-2; 0,606кг/п.м.

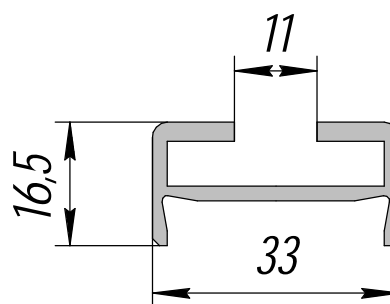

ПК 02090-3; 0,433кг/п.м.

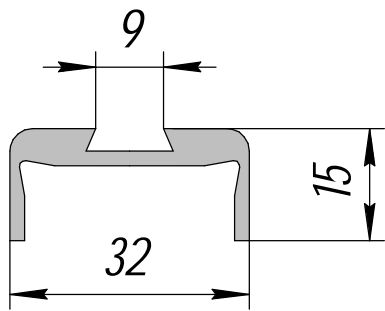

ПК 02090-4; 0,430кг/п.м.

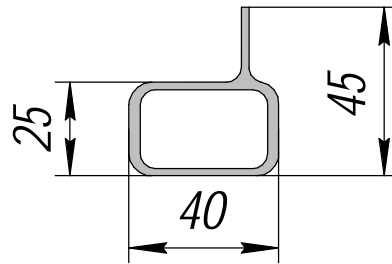

ПК 02090-8; 0,858кг/п.м.

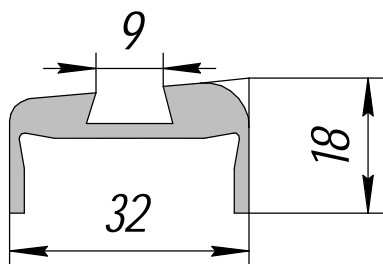

ПК 02090-5; 0,499кг/п.м.

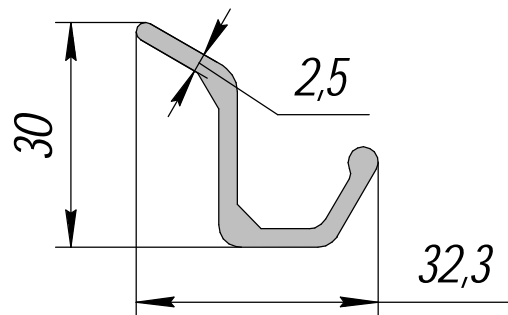

ПК 02105; 0,442кг/п.м.

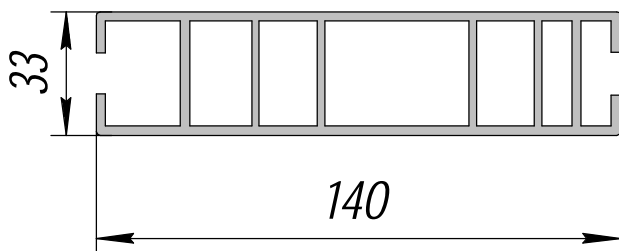

ПК 02090-6; 3,108кг/п.м.

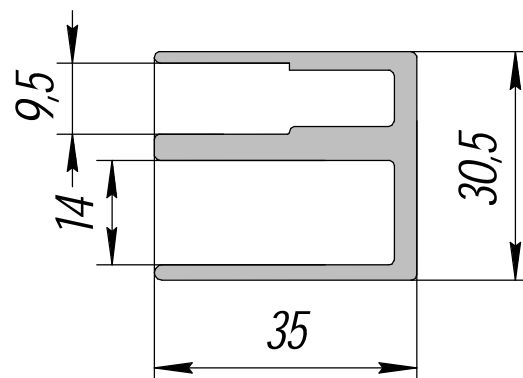

ПК 02170; 0,929кг/п.м.

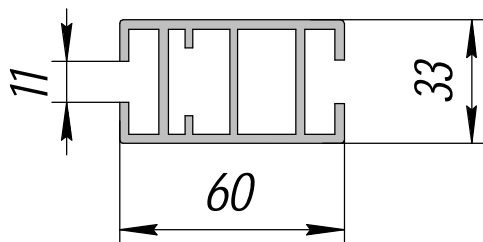

ПК 02090-7; 1,623кг/п.м.

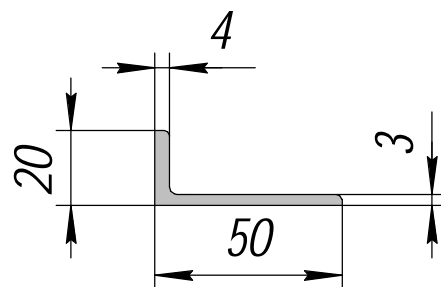

ПК 111-17; 0,591кг/п.м.

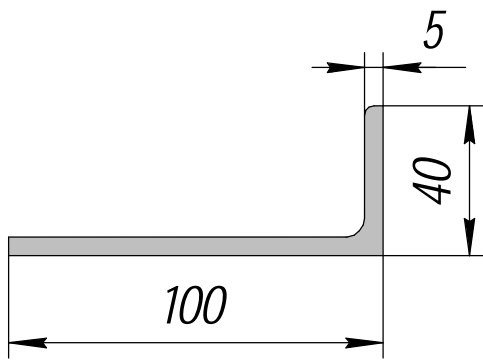

ПК 2-30; 1,881кг/п.м.

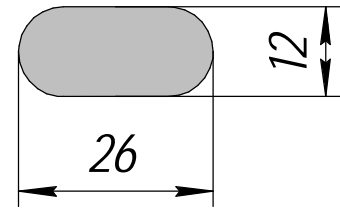

ПК 805-4; 0,762кг/п.м.

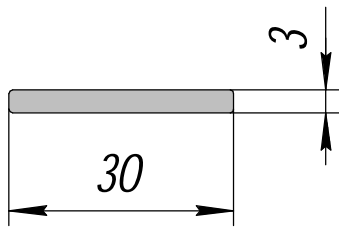

ПК 801-2; 0,243кг/п.м.

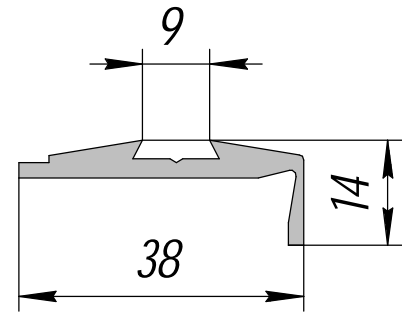

ПК 8267; 0,377кг/п.м.

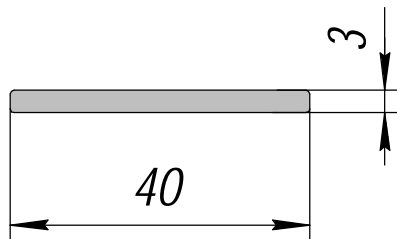

ПК 801-3; 0,325кг/п.м.

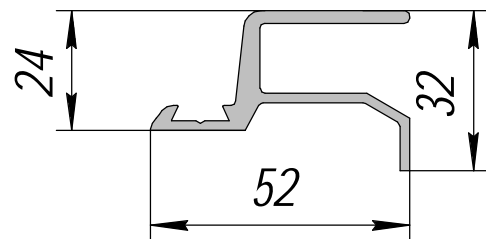

ПК 8268; 0,795кг/п.м.

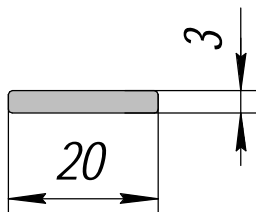

ПК 801-144; 0,162кг/п.м.

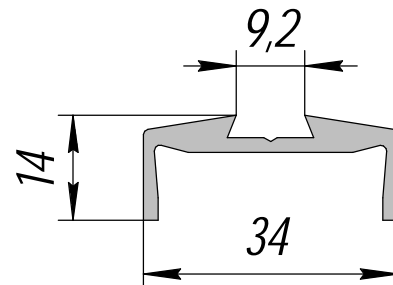

ПК 8270; 0,384кг/п.м.

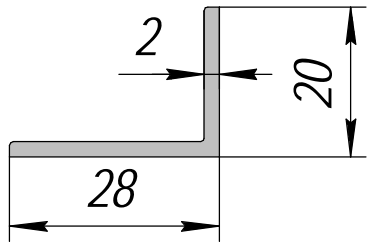

ПК 8271; 0,249кг/п.м.

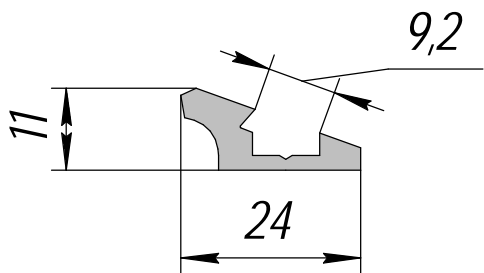

ПК 8486; 0,271кг/п.м.

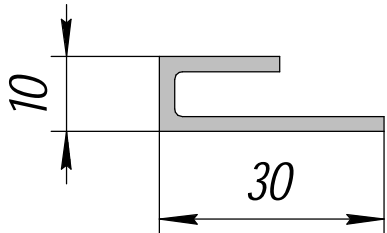

ПК 8487; 0,283кг/п.м.

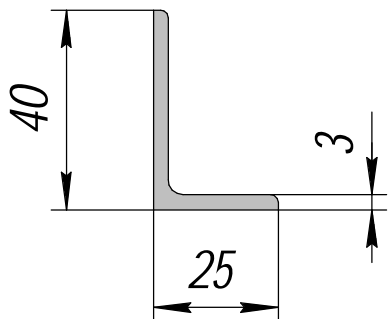

ПК2-337; 0,507кг/п.м.

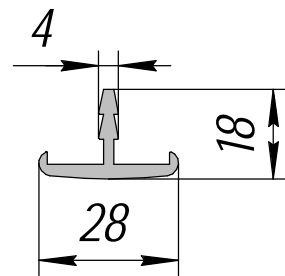

АС-57; 0,325кг/п.м.

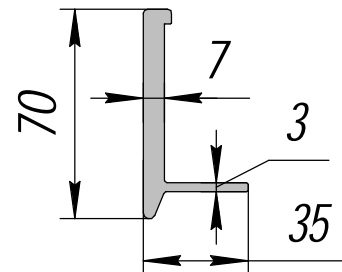

АС-59; 1,540кг/п.м.

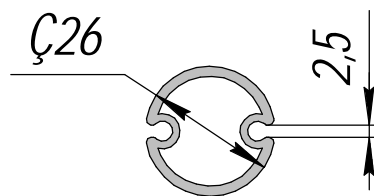

АС-62; 0,469кг/п.м.

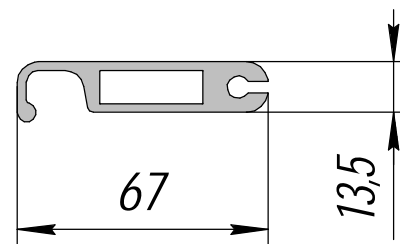

АС-63; 1,191кг/п.м.

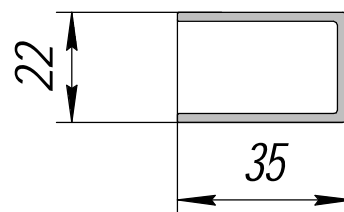

АС-64; 0,478кг/п.м.

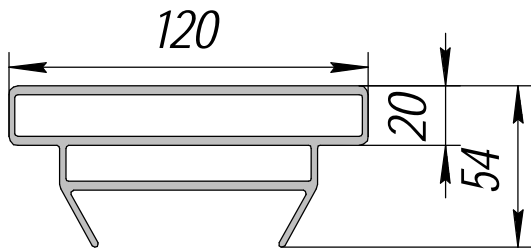

AC-65; 3,149кг/п.м.

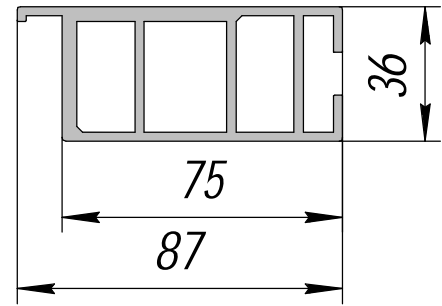

AC-75; 2,362кг/п.м.

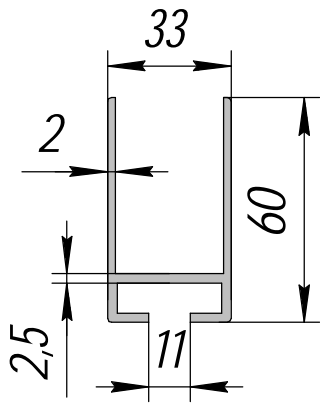

AC-68; 0,988кг/п.м.

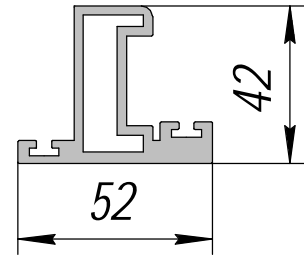

AC-76; 1,460кг/п.м.

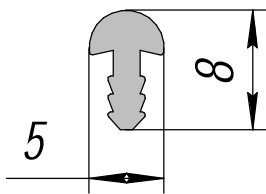

AC-69; 0,059кг/п.м.

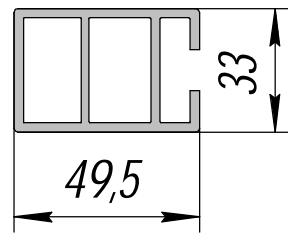

AC-78; 1,315кг/п.м.

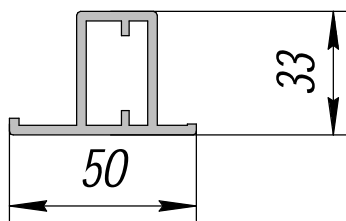

AC-73; 0,922кг/п.м.

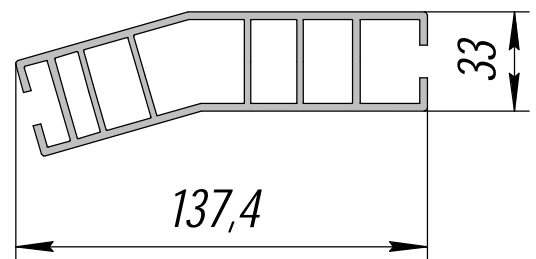

AC-79; 3,047кг/п.м.

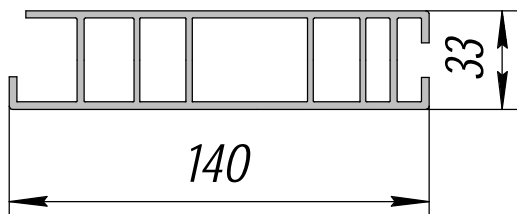

AC-80; 3,015кг2/п.м.

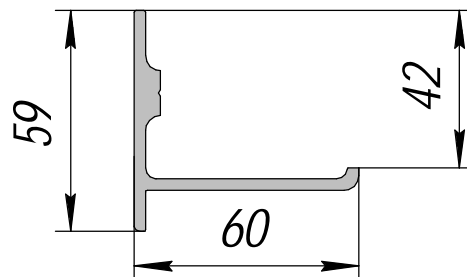

КП-2042; 1,115кг2/п.м.

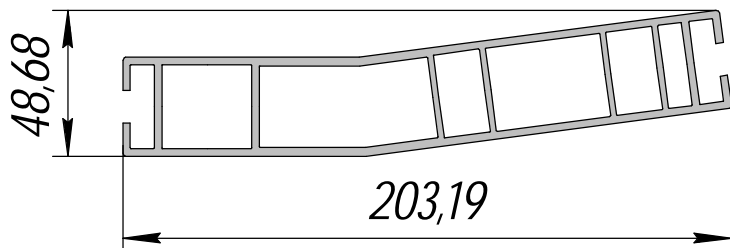

AC-81; 4,444кг2/п.м.

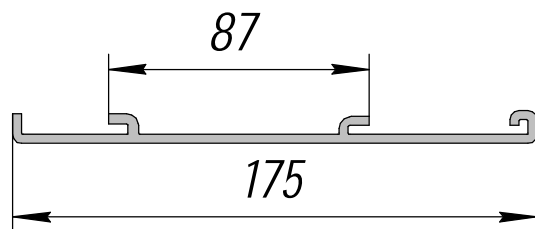

КП-2057; 1,803кг2/п.м.

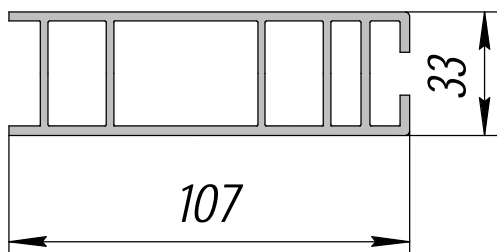

AC-83; 2,358кг2/п.м.

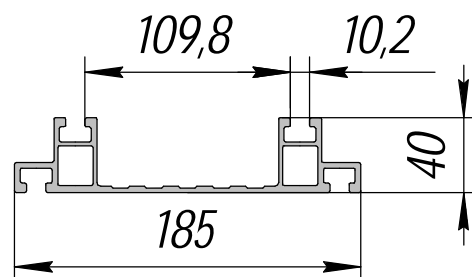

НП-261; 3,409кг2/п.м.

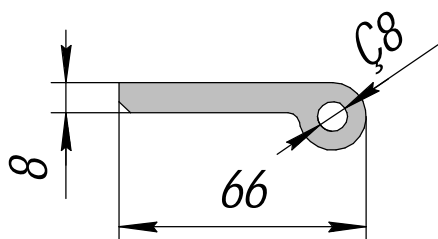

AC-85; 1,633кг2/п.м.

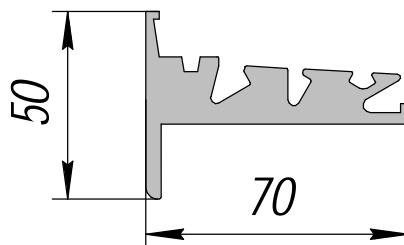

НП-266; 2,624кг2/п.м.

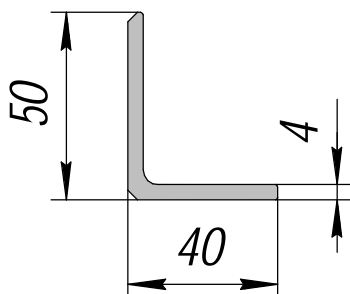

АУ-84; 0,924кг2/п.м.

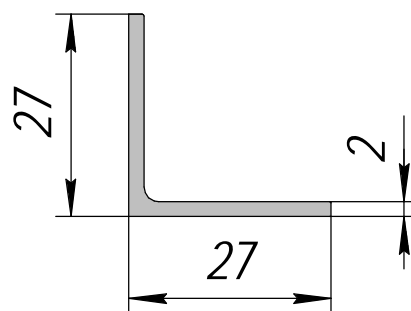

НП-637; 0,284кг2/п.м.

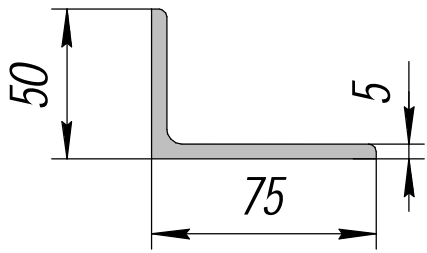

ПР 101-19; 1,633кг/п.м.

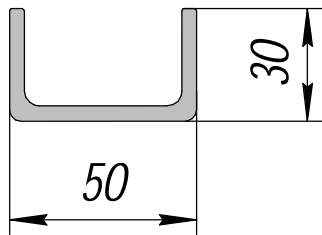

ПР 106-10; 1,138кг/п.м.

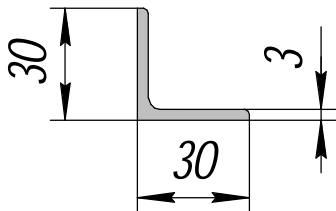

410081; 0,466кг/п.м.

1.3 Профили для велосипедов

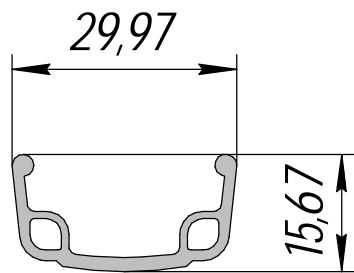

ПП-556; 0,288кг/п.м.